

The Telecommunication Journal of Australia

Vol. 3, No. 3

Registered at the General Post Office, Melbourne,
for transmission by post as a periodical.

FEBRUARY, 1941

CONTENTS

	Page
Some Recent Developments and Trends in our Tele- communication Services - - - - -	125
D. McVEY, A.M.I.E.(Aust.)	
Measuring Instruments - - - - -	140
A. A. LORIMER, M.E.E., A.M.I.E.(Aust.)	
Speech Power, Volume Indicators and the New Volume Unit (vu) - - - - -	146
E. P. WRIGHT, B.Sc.	
Mr. C. McHenry, A.M.I.E.(Aust.) - - - - -	149
Drawer Type Non-Switching Units - - - - -	150
E. J. BULTE, B.Sc.	
Intercommunication Telephones Types A.5 and A.10	153
A. R. GOURLEY, A.M.I.E.(Aust.)	
An Audible Code Call System - - - - -	160
L. T. BATTY and S. MULHALL	
Standard Test Sets - - - - -	163
W. KING	
Aerial Line Construction—Part I. - - - - -	168
A. S. BUNDLE	
Information Section - - - - -	177
Answers to Examination Papers - - - - -	179

THE POSTAL ELECTRICAL SOCIETY OF VICTORIA

The Telecommunication Journal of Australia

Vol. 3, No. 3

February, 1941

SOME RECENT DEVELOPMENTS AND TRENDS IN OUR TELECOMMUNICATION SERVICES* D. McVey, A.M.I.E.(Aust.), Director-General, Posts and Telegraphs

Since the Australian Post Office is responsible for the provision of the telephone and telegraph services of the Commonwealth, it has, of necessity, to keep in close touch with the latest developments in the art of telecommunication. The differing types of service being rendered and the equipment used to provide such services reflect, in general, the state of development of the art, not only in this country, but, to quite a considerable degree, throughout the world.

The home of the telephone—the United States of America—is, as is well known, the country most highly developed in telecommunication services. More than half the telephones of the world are found there. Australia is a country of somewhat similar area, although possessing very much smaller population. It is also a relatively new country, but it is rapidly becoming what U.S.A. already is, viz., highly industrialized. These parallels have been appreciated by the Post Office Administration here, which has not been slow to realise that conditions are at times very suitable for adoption in the Commonwealth of new methods affording telecommunication service that have been developed in the United States. Here, our specialists, scientists, engineers and others are continuously occupied in seeking new ways and means that will enable intelligence to be conveyed more rapidly and economically—whether by telephone, telegraph or radio. For example, the new 12-channel open-wire carrier telephone system recently installed between Sydney and Melbourne was one of the most recent developments of the Bell System.

On the other hand, features of the American system are not always suitable for adoption in this country. Other methods may be more adaptable for local conditions, e.g., in the case of broadcasting in particular. In America, all broadcasting is on the sponsored commercial basis. In Australia, programmes are provided not only by commercial sponsors, but also by a statutory authority, the Australian Broadcasting Commission.

As I have suggested, certain developments abroad may not always be suitable for application in Australia, due mainly to the differences existing in density and distribution of population. Take the case of "wide-band coaxial" cable telephone systems, the development of which in both England and America has been made necessary by the great number of telephone and telegraph channels required between certain large centres of population, e.g., between London and Birmingham, New York and Philadelphia. With two such cables—a "go" and a "return"—upwards of 250 telephone channels can be provided without mutual interference. In this country, whilst development is rapid on certain of the heavy routes, for instance, Sydney-Newcastle, there is not yet a case for a wide-band coaxial cable.

In automatic telephone switching there have been developments in overseas countries which are applicable to very large cities. In the step-by-step system we now use, the most interesting development was the Director system, introduced in London. As, however, the number of lines in the largest of our cities is within the capacity of a six-figure system, the Director system has not been introduced into the Commonwealth.

It may be of some interest at this early stage to refer briefly to trends in the art, which are indicated by certain experimental systems recently being given attention. In technical literature, details were furnished not long ago of a new system of transmission using a copper pipe, either hollow or filled with an insulating material and transmitting very high frequencies of the order of 4000 million cycles. Assuming band widths for telephone channels of 4000 cycles, it would appear that something like 1,000,000 telephone channels could be derived from one conductor if such a number were ever required. The system has possibilities for television, where we speak in band widths of millions of cycles. These systems have been called Hyper-frequency wave or dielectric guides.

A development of a somewhat different kind, and yet not unrelated, has been the investigation

*Lecture delivered before Postal Electrical Society of Victoria on 10th February, 1941.

into the carrier nature of speech recently undertaken in the Bell Telephone Laboratories. The name "Vocoder" has been given to the equipment which analyses speech and afterwards synthesizes it. The investigation has shown that for the transmission of intelligence it is not primarily essential to transmit the whole of the voice range. By substituting a piece of electrical equipment for the vocal organs, the transmission of certain control or speech defining currents of very much lower frequency than the full voice range enables intelligible speech to be reproduced. The Bell people suggest that "these speech defining currents have features of simplicity and inaudibility which may open the way to new types of privacy systems, or to a reduction in the range required for the transmission of intelligible telephonic speech."

Statistics

At this stage it is thought that some reference to statistics will be of value in order to show the increase in telecommunication services despite such setbacks as the depression.

Telephone Stations—(Fig. 1). — 1930 represented a peak in connections, the depression thereafter causing a trough the lowest point of which was reached in 1932. The increase has

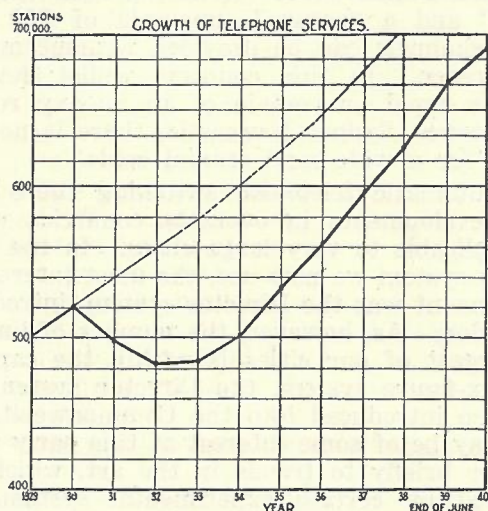

Fig. 1.—Telephone Development, 1929-1940.

been maintained since that time. The latest figure, for December, 1940, is our record figure—704,868 stations.

Wire Mileage. — To those interested in high figures, wire mileage may prove something of an attraction. Figures for several years past reveal that there is nearly three times as much wire mileage in cable as in open wire. Moreover, the cable mileage is increasing rapidly, whereas open-wire is almost stationary. The mileage in cable at present is 2.3 million miles.

Carrier Telephone Channels.—The increasing use of the carrier method of providing trunk circuits is indicated by the growth from 19,000

miles in 1930 to 81,000 miles of channels in 1940. The total trunk channel mileage, i.e., physicals, phantoms and carriers in use now is approximately 280,000, so that the carrier represents more than one-quarter of the total.

Plant Investment.—Some figures have been prepared showing the total value of the Fixed Assets of the Telephone, Telegraph and Broadcasting plant for the period 1929-1940. These details, which appear in Fig. 2, include an allowance for sites and buildings. It will be remembered that in many of our offices telephone and telegraph services are conducted jointly with postal business. Whilst there is a natural up-

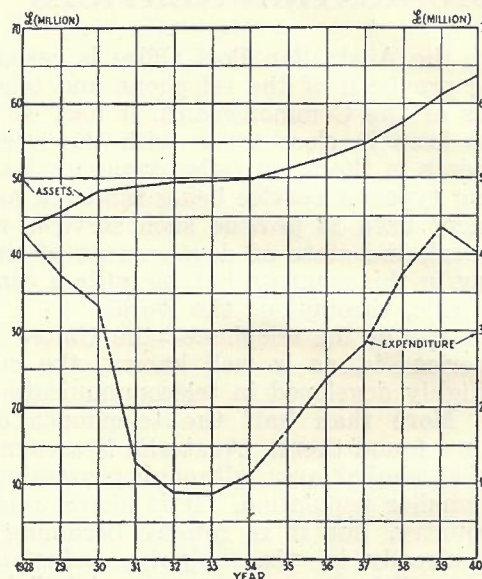

Fig. 2.—Plant Investment, 1929-1940.

ward trend, the rate of increase was slowed down during the depression years, 1931-1934, due to falling off in the rate of expenditure. An idea of the magnitude of the activities can be gained from the fact that the Plant Expenditure for the year ended June, 1940, was over £4,000,000, and the Asset value of plant amounted to almost £64,000,000. Whilst it is not possible at the moment to give a figure representing the staff employed on purely telecommunication work on account of the joint nature of the duties of many officers, it is of some interest to note that, exclusive of mail contractors, there were some 47,017 officers in the service at June of last year.

Broadcasting.—The remarkable development of the broadcasting service is indicated by relative figures for the years 1930 and 1940, both in respect of broadcasting stations and listeners' licences. In 1930 there were 8 "A" class stations, 23 Commercial stations, and 312,382 listeners' licences. In 1940 the National stations (including our 2 short wave stations) numbered 28, the Commercial stations 100, whilst the listeners' licences had increased to the very high figure of 1,212,581.

THE TELEPHONE SERVICE

Substation Equipment

Handset Telephones.—An important development in the telephone service during the last ten years was the introduction of the handset telephone. At first, the handset was sought eagerly by subscribers, because of the increased convenience provided, but its use has been encouraged since by the Department for the reason that it has become an essential part of our modern transmission plan. Other telephone administrations had introduced the handset a little earlier than the Australian Post Office, and we were fortunate in having the benefit of their experience.

One of the chief problems with which the Administration was confronted in the introduction of the handset was the fact that the existing stocks of older type instruments were in most cases capable of furnishing reasonably good service for quite an appreciable period, and they also constituted an asset of considerable monetary value. The rate of introduction of handsets was, therefore, controlled carefully so that the recovered instruments of the older type could be renovated and re-issued for some services, thereby spreading the period over which

covered instruments (either wholly or in part) was applied to the magneto wall type telephone. The original practice of mounting table type instruments on brackets on the wall is being abandoned and proper wall type instruments, converted in the manner mentioned, have been introduced. In all cases, the converted types of handset telephones have contained the latest circuits and, like the table type, have side-tone suppression.

The effect of sidetone is rather interesting. The speaker does not hear his own voice loudly and, therefore, "speaks up" a little more than ordinarily. This produces a little better sending level than might otherwise be the case. The application of reduction in side-tone has been gradual; but as the level of the modern transmitter is high the side-tone feature is essential, and it is used in all our telephones of modern type.

Coloured telephones have been in use in other countries for several years. Some colours were obtained by lacquering, but later most of the colours were incorporated in the plastic materials from which the telephones were moulded. This Administration declined to introduce coloured telephones until improved plastic material became available. As the earlier materials, of which sample coloured telephones tried out in this country were made, showed discolouration and cracking, it would have been a serious matter to have introduced the innovation without awaiting the development of satisfactory materials. The material now used is "Diakon" and it gives good results; the colours do not fade and the material does not crack. We have been able to obtain instruments in this material guaranteed in three colours only—ivory, green and red. The cords are coloured to match the telephone, and the dial is stainless steel in each case. A special tariff is charged, as the instruments cost more than ordinary telephones, while special parts have to be stocked and provision has to be made for a higher rate of replacement.

Some countries use as many as nine colours, but in Australia, where we are subject to extremes of climate, we have to proceed carefully with the introduction of additional colours.

Our current model telephone is being manufactured in Australia as well as in England. A feature of the design is the manufacturing advantages it affords. There is room in the moulding for the addition of up to three press keys, which can be fitted for auxiliary services. The method has been introduced in England and subscribers have a choice of various "plans." The press keys operate various combinations of spring sets which are fitted within the moulding. This system is very attractive and its introduction into our service is under consideration.

Another interesting feature of the current model handset is that we have taken advantage

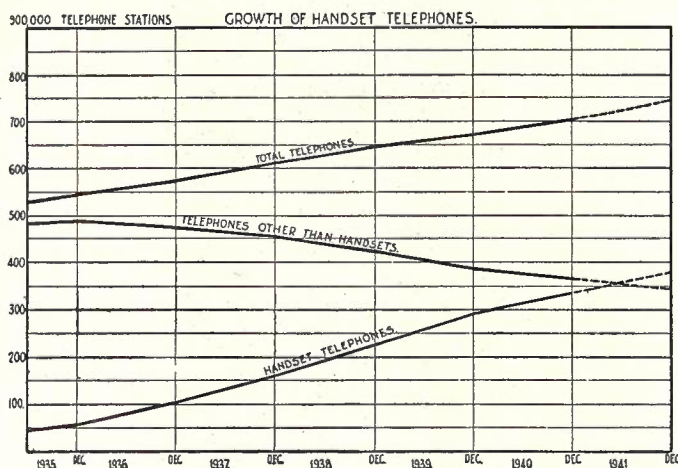

Fig. 3.—Increase in Number of Telephones, 1935-1940.

the obsolescent instruments would otherwise be scrapped. Fig. 3 shows the growth in the number of handset telephones in service. An interesting local development, too, was that our Engineers found a way to convert economically the bellset portion of the old type table telephone into a wall type handset telephone, which has proved quite as good for modern service as the handset table telephone. By this means the Department has been placed in the fortunate position of limiting its purchases to telephones of the handset type, and to table models only.

The same principle of adapting for service as a modern instrument a suitable number of re-

of the space available in the moulding to include a magneto hand-generator, which is placed in the space occupied in the case of the automatic telephone by the dial. This enables a completely self-contained magneto handset telephone to be provided. An interesting point is that we were careful to specify the torque and generator output; but the specification stated only the minimum output. When deliveries arrived it was found that the generators had a higher output than was expected, and as they were much too hard to turn it was necessary to provide a magnetic shunt to reduce the torque to a comfortable point. The high output of these modern generators is due to the small but powerful magnets, which are made of the well-known alloy, "Alnico."

Before passing on to other items of substation equipment, it is desired to refer briefly to the part which is played by the handset telephone in our modern transmission plan. In 1926 our standard was for all network connections to be not inferior to the grade of transmission provided by a test connection, which, in C.C.I.F. terms, had a Reference Equivalent of the order of 47 db. In 1935, a new test connection was specified having a Reference Equivalent of 29 db. The handset telephone was one of the transmission aids which made that new standard economically practicable. There were other transmission aids, such as the carrier telephone system and the voice frequency repeater, which added to the technique in common use previously.

Both the old and new standards mentioned were of volume reference only, circuits being rated in terms of the volume of speech transmitted over such circuits. In passing, it should be mentioned that, as has been realised for a long time, such a basis of comparison is inadequate because it does not take into account other important factors such as line noise, room noise, the effect of side-tone, reactions of subscribers and modes of speaking. To meet this need, and thus more adequately rate the efficiency of a telephone connection, a new method—Effective transmission by the Repetition Rate Method—has been introduced in America and was about to be adopted in Great Britain at the outbreak of war. Briefly stated, comparison with a standard circuit is now made on the basis of the number of repetitions called for by the listener, the connections being under observation continuously during the progress of test calls.

Intercommunication Telephones. — Other improvements in substation equipment relate to the introduction of intercommunication telephones with exchange facilities, made in two sizes—1 exchange line plus 5 extensions, and 2 exchange lines plus 10 extensions. These telephones eliminate a manual switchboard and provide many other advantages, such as direct call-

ing between internal extensions, conference facilities and exchange call transfer.

Public Telephones.—Public telephones must be mentioned because this item is more important than is generally recognised. At intervals, new models of telephone cabinets are introduced and there have been several types of public telephone instruments. In addition, these instruments are in great demand for private use in guest houses, etc.

In designing telephone cabinets, all countries have had their own peculiar difficulties. Some variations in design and materials are to be expected because of differences in climate. For the full length type, the materials used have been wood, concrete, cast iron and sheet metal; while on the Continent circular glass cabinets are in use. The amount that may be expended in a full length cabinet structure depends on the revenue returns, the climatic conditions to be observed, and sometimes, too, on the wishes of the local Government authorities.

For a long time the cabinets most commonly used here were wooden with glass panels in the upper sections of two sides and the door. These

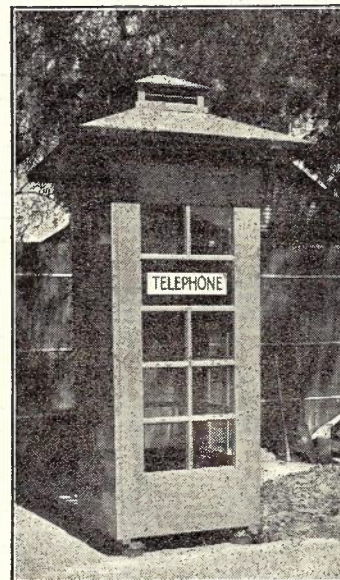

Fig. 4.—Typical Wooden P.T. Cabinet.

still meet requirements reasonably well, but their appearance is not as attractive as when more glass is used, and so, in recent years, we have increased the amount of glass. A typical cabinet is shown in Fig. 4. More glazing means that the cabinet may become uncomfortably hot, but the arrangement that has been adopted is a reasonable compromise to provide good appearance at low cost without introducing intolerably hot conditions.

In Melbourne, trials were conducted of several types of concrete cabinets, one type being quite

attractive, but all the concrete types have the disadvantage of high cost, and they have not the aesthetic appearance of other types.

In England, the British Post Office produced the "Kiosk" type and arranged for the design to be prepared by an eminent architect (Sir Giles Gilbert Scott, R.A.). As this design was favourably received in England, the Australian model was produced—using the general shape and appearance of the British design—for the simple reason that as so much thought had been given in England to the design it was considered doubtful if we could do better. The British P.O. cabinet was made in concrete sections and also in cast iron, which is now the British standard. We decided to make ours in sheet steel, with hollow walls; but this decision brought difficulties in its train. Sheet steel, however, provides manufacturing advantages and we intend to persevere. Cork lining has been used, and the roof is moulded in asbestos cement. The ceiling is composed of material having an asbestos base and acoustic absorbent properties.

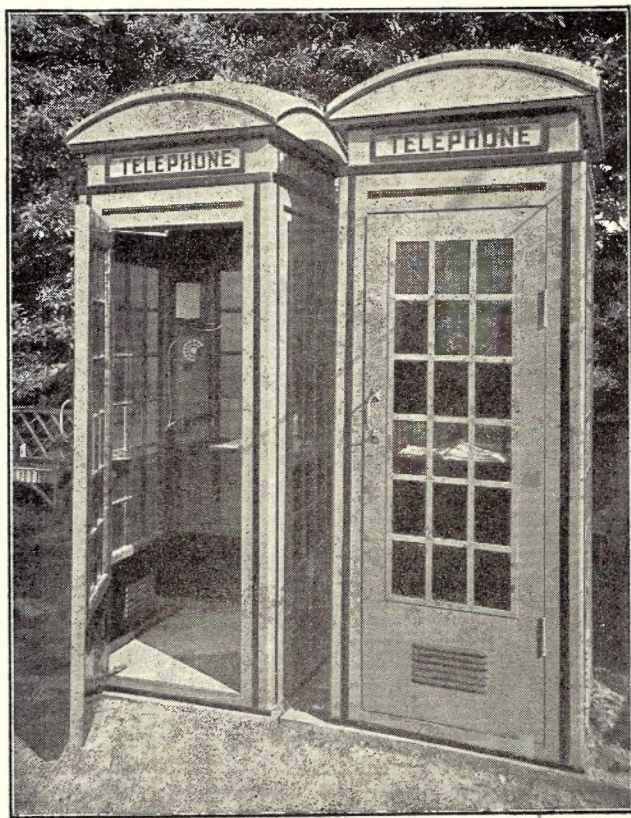

Fig. 5.—Sheet Steel P.T. Cabinets.

A ventilating fan has been included and special glass is used, which reduces the heat from the sun's rays. It had been the practice not to glaze the rear wall of a cabinet, but in order to improve the appearance of our cabinet uniform glazing has recently been provided on all sides

and in the door. In order to accomplish this, it was necessary to redesign the instrument so that it could be mounted in the corner. Fig. 5 shows this cabinet. A parcels shelf is provided and a mirror.

For cases where the calling rate is expected

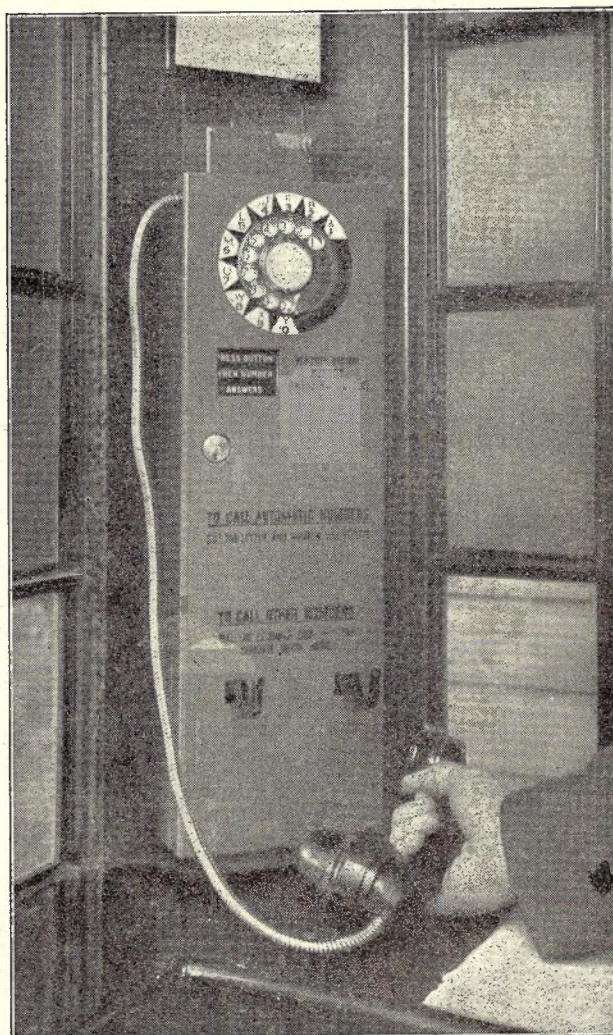

Fig. 6.—Corner Type Public Telephone.

to be low, head type and half length cabinets have been provided, but the tendency is to abandon the former type and to use only the half or full length type. Of late the half length is being used only in a few cases.

Public Telephone Instruments. — Public telephone instruments of several types are in use; the single button type, standardised for local service, is well known and is our own development. The latest design (see Fig. 6) used for corner mounting in the steel cabinets was developed recently and contains a number of improvements. Models are under field trial at present and results are encouraging. The instrument is finished in vitreous enamel for good

appearance and cleanliness; an enlarged number ring forms part of the case; an instruction signal to the subscriber is incorporated; and a handset with flexible metal cased cord is used. The coin container space has been increased to reduce faults which have been caused from overflow of coins due to delay in effecting clearance of the tins.

Private Branch Exchanges.—It is not necessary to stress the importance of Private Branch Exchange equipment. With the growth of the service, many thousands of P.B.X. switchboards have been installed in the premises of subscribers. Sizes have been standardised with the object of reducing the number of types to be purchased. Important objectives in the design have been simplicity of operation, reliability and ease of maintenance. With the growth of modern automatic service, there have been recent developments in P.B.X. design.

One trouble has always been that, when an extension calling through the P.B.X. to the main exchange completes the call, the exchange equipment is held until the P.B.X. telephonist clears. On occasion, the telephonist delays taking down the connection, and the effect of this on the exchange equipment is serious. At busy seasons and in the busy hours at large city exchanges traffic blocks are caused through equipment being unnecessarily held up by many P.B.X.'s. This problem has been solved by the development of P.B.X. circuits which provide for the release of exchange lines when the extension clears—i.e., the exchange equipment is cleared even though the telephonist may delay disconnecting.

Provision is also being made for "through dialling" on cord switchboards.

On new P.B.X.'s lamps will be used instead of indicators. In recent years metal filament switchboard lamps have been developed. They are of low current consumption and in some of the circuits direct signalling becomes practicable without the use of relays.

Private Automatic Branch Exchanges.—Since 1934 the number of P.A.B.X.'s installed by the Department has increased from 39 to 260, serving 34,000 lines. There is a very great demand for this class of service and the Department has adopted several standard sizes to simplify purchase of supplies, installation and maintenance. There are many special features and improvements have been effected in recent years, but the details could hardly be covered within the scope of this paper. Perhaps it will be sufficient to mention that there are three main types:

- (1) Units types, up to 50 extensions.
- (2) Line finder types, up to 90 extensions.
- (3) Large installations of 100 lines or over using 100 line uniselector units.

Exchange Equipment

Manual Equipment.—Our practice has been to use common battery switchboards only in metropolitan areas and in large towns, e.g., Launceston. Multiple switchboards employing lamp signalling, but magneto operated, are in use in a few large country towns. Otherwise we have continued to use the non-multiple magneto system in the country and when a change becomes essential it has been made directly to automatic working, recent examples of this policy being Wagga and Rockhampton. There are some cases of large exchanges which must be re-equipped with manual switchboards, and because we cannot wait until it is possible to provide automatic equipment, we have developed standard carcasses which will be suitable for subscribers' positions, and when these are no longer required for that purpose they will be suitable for conversion to trunk positions. Circuits have been developed which will permit the application of C.B. signalling from the existing magneto instruments, while for new subscribers standard C.B. instruments will be installed.

The object is to secure the benefit of lamp signalling, and at the same time avoid purchasing magneto apparatus and instruments which are obsolescent.

Automatic Switching.—As in other countries, our problem is to provide for converting existing manual exchanges to automatic working and at the same time to meet the growth of existing automatic exchanges. Moreover, some of the early automatic exchanges have reached the stage where substantial replacements are necessary. The development in new services has been phenomenal in recent years and, as it was obvious the Department had to embark upon a large construction programme, opportunity was taken to standardise the latest equipment obtainable, this being the now well-known 2000 type equipment.

Exchanges of this standard type have been installed, using equipment supplied by one American and five British manufacturers. For all practical purposes, the equipment is interchangeable, and this is an interesting example of British type equipment being manufactured in America. Our engineers have been closely identified with this development, and many difficult problems have been solved. Such standardisation has been the most important development in this field and it has facilitated the construction programme.

The equipment details do not come within the scope of this paper, as various sections of it have been described in previous papers published in the Journal.

It may be of interest to mention that the adoption of this type of equipment included the use of line finders for most of the exchanges, although for one very busy city exchange uni-

selectors are used. This is the City West (Melbourne) exchange, and the uniselectors are of recent development. They contain an operating improvement over previous subscribers' uniselectors, in that although the homing principle is employed the uniselector will not necessarily select the first idle trunk, but will pass a faulty trunk, thus selecting the first idle serviceable trunk. The design of this switch also makes possible another important improvement, i.e., saving of space, by mounting 300 per rack instead of 200, which was the previous standard. This is a vital improvement, especially in a city building, where conservation of space is an important consideration.

A motor uniselector was developed in recent years and is used in a London exchange and for some special services overseas. It has not been used in our exchanges for subscribers' services, but, as will be mentioned later, it is being utilized in connection with the Melbourne trunk exchange. This switch has some very good features, but is to be compared with the line finder rather than with the subscribers' uniselector.

The B.P.O. standard uniselector is used at many points in our equipment and is giving good service. It has been superseded by the City West

politan exchanges have been installed, and that there has been a very substantial increase in country automatic exchanges, although many of these are "rural" exchanges. At the same time, existing exchanges have been extended to a remarkable extent. Since 1930 the metropolitan automatic total has grown from 138,000 to nearly double that figure, and the country automatic total has increased nearly four-fold.

Rural Automatic Exchanges. — In this field, early developments were confined to experimental installations. After considering the types of rural automatic equipment used in other countries, it was realised that we had some problems which were not quite the same as those encountered in Europe and America. We have proceeded rather carefully, our first equipments being specially constructed by our own staff to meet Australian conditions. Later installations were equipments manufactured to our specifications. More recently we revised our designs to include standard types of relays and other standard equipment as far as practicable.

In selecting localities for this system we have concentrated on exchanges which are nearing the continuous service stage, or places where there has been difficulty in securing service under

TABLE I.
Development figures, 1932-1940.

	At 30/6/32	At 31/12/40	Increase
Metro. Automatic Exchanges:			
In service	64	98	34
Being installed or on order	—	10	—
Total:	64	108	44
Country Automatic Exchanges:			
In service	6	127	121
Being installed or on order	—	36	—
Total:	6	163	157
Metro. lines	193,000	316,000	123,000
Metro. Automatic lines	138,000	268,000	130,000
Percentage of lines Automatic	71.43%	84.80%	13.37%
Country lines	170,000	200,000	30,000
Country Automatic lines	3,800	14,300	10,500
Percentage of lines Automatic	2.21%	7.13%	4.92%
Combined Country and Metro. lines	363,000	516,000	153,000
Combined Country and Metro. Automatic lines	141,800	282,300	140,500
Percentage of lines Automatic	38.94%	54.73%	15.79%

type for regular uniselector service only for the reasons mentioned.

Table I. shows some figures which will give an idea of the extent to which recent developments in this field have been applied. The statement does not include existing automatic exchanges where major replacements have been effected. It shows that a large number of metro-

manual conditions, either because the Postmaster cannot undertake the switching work or because the conditions are in some way unsatisfactory.

Our R.A.X.'s invariably are isolated automatic units associated with a nearby parent exchange, which is usually the nearest continuous service manual exchange capable of giving the trunk service required. The R.A.X. gives full auto-

matic service, including public telephones and party lines. The equipment is arranged on a unit basis, having an ultimate capacity of either 50 lines or 200 lines. The buildings are of standard types, the design being simple but effective, and the numerous special requirements for an unattended automatic exchange have been incorporated. At present there are 128 R.A.X.'s in service with 5000 lines connected, whilst an additional 30 R.A.X.'s are being installed.

Unit Automatic Exchanges were developed by the British Post Office in recent years. The units we have used are U.A.X. No. 12 and U.A.X. No. 13, i.e., capacity for 90 and for 200 subscribers, respectively.

The equipments are constructed of regular standard parts and are similar to R.A.X. equipments, except that they are more elaborate and can be used not only for rural exchanges but also for some automatic network exchanges, and in some cases for metropolitan service. In the larger sizes they commence to become complicated and we have preferred to use built up standard equipment rather than the still larger R.A.X. No. 14 for exchanges between 200 and 800 lines.

Trunk Exchanges.—New trunk exchanges have been provided at Wagga and Rockhampton. They are modern standard lamp signalling manual trunk switchboards of 12 and 8 operating positions respectively and have very complete facilities, including key senders for connecting calls to the associated automatic exchanges. They were supplied by British manufacturers, Standard Telephones & Cables and Automatic Telephone and Electric Co., who in each case also supplied the automatic switching equipment.

The two most important works carried out in recent years in this field have been new trunk exchanges for Sydney and Melbourne. The first was manufactured and installed by our own staff. It consists of 84 operating and 17 service positions. Many operating aids are incorporated, including key senders on the trunk positions and trunk timers in the cord circuits. Provision is made for 4 wire switching by means of an auxiliary multiple and auxiliary cords, with automatic lamp indication to the operator, conveying an instruction when an auxiliary cord is to be used.

The Melbourne automatic trunk switchboard was supplied by Siemens Bros. & Co. Ltd., London, who have provided a unique equipment. After producing the original design and scheme, they have modified it to suit local requirements. Great credit is due to the manufacturers. A section of the switchboard is working, and when completed this will be the largest automatic trunk switchboard in service anywhere. The equipment occupies two floors, the manual positions and pneumatic tubes are on one floor and the automatic equipment is on the floor below.

Prior to the introduction of this type of equip-

ment at the Melbourne Trunk Exchange, automatic trunk boards had been used for smaller installations supplied by Siemens Bros. at Cape-town, and by Automatic Telephone and Electric Co. at Johannesburg, South Africa. Those installations include some of the principles employed here, although they use different types of automatic equipment.

Automatic Electric Co., Chicago, have carried out some work in this field, and have supplied equipment to Sao Paulo, Brazil.

Trunk Switching.—In Europe, subscriber to subscriber dialling over trunk lines is permitted, and ingenious methods of call registration and automatic ticket printing have been developed. These methods are more applicable to countries smaller than Australia, where our very long and costly trunk lines make it necessary that they be controlled by a telephonist. We have developed, substantially, long distance dialling by telephonists, who directly call the distant automatic subscriber, but beyond this operation it would be unsafe to go at present.

Voice Frequency Signalling.—Methods of signalling over trunk lines have been the subject of special attention for some years past, and voice frequencies have been used to transmit ringing signals over trunk lines. The reason is that such signals pass readily through the transmission circuit, whether it is a carrier channel or includes voice frequency repeaters, whereas normal 16 cycle ringing currents do not have these advantages. We have been using 1000 cycle tone to convey the pulses of ringing current. In recent years the use of voice frequencies has been extended to provide for impulsing and supervision. This important development has been adopted extensively in England and the system will be installed throughout Victoria.

The system employs 600 cycle and 750 cycle currents transmitted to special receivers at the terminals. In general it can be assumed that the limits for signalling over a circuit are the same as those of speech. The system will supersede some of the present dialling arrangements, whereby dialling is carried out over a superimposed channel, such as that of a composite circuit.

TRUNK TRANSMISSION EQUIPMENT

Although **Carrier Telephone Systems** have been in operation in the Commonwealth since 1925, there have been many developments in recent years. The great extension of the system is itself an important development, but in the systems themselves there have been many improvements, due to the application of improved technique. The most important have been—better characteristics giving improved service; simplified construction, making it possible to install more equipment in existing space; and reduction in cost. A most interesting develop-

ment has been the beginning of local manufacture of this equipment. This provides opportunity for closer co-operation between the manufacturers and the Department than has been possible in the past, and at the same time there is an opportunity for greater standardisation.

The importance of carrier will be gleaned from the fact that since our first system was installed in 1925 between Sydney and Melbourne, there has been an increase to 178 systems, comprising 337 channels and a total channel mileage of 81,190.

Three of the original systems, which transmitted the carrier to line (Type B), are still in use on somewhat isolated routes; all later ones are of the carrier-suppressed type, which gives considerable improvement over Type B from the point of view of crosstalk.

Fig. 7 shows the various types of carrier systems, together with the frequency range which each occupies. Some idea of the use which is made of the frequency spectrum available on a pair of suitable open wires can be gained from the fact that one v.f., one 3-channel system and one 12-channel system—in all 16

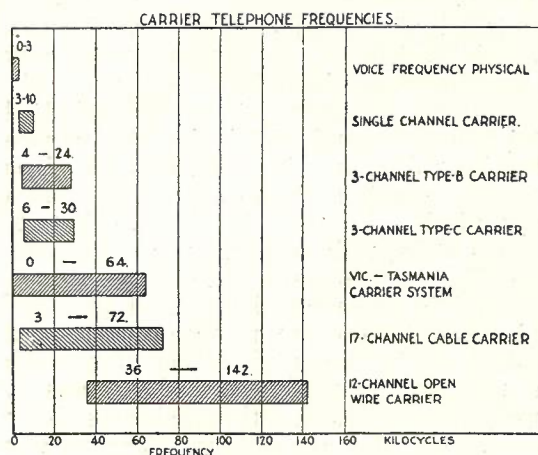

Fig. 7.

telephone channels—as well as several duplex telegraph channels, may be operated simultaneously, i.e., without mutual interference. The economies which have resulted from the application of carrier telephone systems are very great indeed. The Tasmanian system cable carrier and 12-channel open wire carrier are important recent developments.

Tasmanian Cable System.—Telephone service to Tasmania from the Mainland was given in 1936, when a special single core paragutta insulated concentric cable was laid in two sections, Apollo Bay-King Island, King Island-Stanley. Associated with this cable is an extensive equipment installation whereby one voice-frequency channel, six carrier telephone channels and one reversible carrier programme channel have been provided with a frequency range extending up to

42.5 kilocycles. The system has been the subject of a separate paper. An order was recently placed for two extra telephone channels whereby the upper frequency limit will be increased to 64 kC.

Carrier-in-Cable is a development of importance which has recently been introduced in the Commonwealth. It is the application of the carrier system to long trunk cables. Our first installation is that between Sydney and Maitland, where two cables—one “go” and one “return”—have been laid and will have superimposed upon them 9 and 17 channel systems on frequencies up to 72 kC with repeater stations at approximately 20-mile intervals, some of which will be unattended. Where the number of channels on long routes is such as to warrant the provision of trunk cable, carrier is frequently more suitable than loaded voice frequency circuits, since it is capable of extension to thousands of miles before the finite time of transmission becomes a limiting factor—as it is with long loaded voice frequency circuits, due to the addition of inductance. In connection with the Sydney-Maitland carrier cable project, the invasion of Holland last year has prevented the delivery of much of the carrier equipment, but steps have been taken to complete manufacture in Australia. Meanwhile we hope to get some channels into service by using the completed cable and some of the equipment on hand.

12-Channel Open Wire Carrier Systems.—One of the most interesting recent developments in this country has been the introduction of the 12-channel carrier system of the Western Electric Company, covering the frequency range 36-142 kilocycles. The wide frequency range required in this system as against the cable system is due to the fact that two physical wires only are used compared with four (two “go” and two “return”), and therefore different frequencies must be used for the opposite directions of transmission. The first system to be installed in Australia was placed in service between Sydney and Melbourne in November, 1939. The system has been remarkably free from troubles.

Voice-Frequency Repeaters.—The extensive use of the voice-frequency repeater has resulted in many improvements. On open wires, in an endeavour to provide a better grade of service, repeaters at the terminals of trunk lines have been introduced. Of special interest is the long voice-frequency circuit between Port Augusta and Kalgoorlie, a link of 1000 miles in the Adelaide-Perth circuit. At Cook, the central repeating station, a “stabilised” repeater has been installed. This is an interesting new development. In effect, the repeatered line is divided into two sections, thus considerably reducing the possibility of singing; and allowing the circuit to work normally at a lower transmission loss. These repeaters are voice-operated

devices and have certain limitations, e.g., it is not practicable in their present form to operate two in tandem in any one connection, because of possible lock-out resulting, temporarily, in completely blocking transmission.

A recent development is the extensive installation of v.f. repeaters in connection with loaded cables, 45 miles in length, two of which are provided between Melbourne and Geelong, for 4-wire working. Other installations of this type are the loaded cables recently completed between Melbourne and Dandenong, and Melbourne and Frankston.

OUTSIDE PLANT

General.—The developments of recent years have been the need for more precise construction methods of open wire and more scientific design in the make-up and actual installation work of cables for trunk, junction, and subscribers' lines. These improvements have become necessary because of the developments in the apparatus applied to these wires for deriving channels over a wide frequency band. The upper limit has been increased for open wires by modern practice, from 3000 to 140,000 cycles; and from 3000 to 72,000 cycles for cables. These changes have introduced many problems relating to the characteristics of material used as well as to construction methods; while the multiplicity of channels over some lines has caused a need for better maintenance methods. An interruption to a line is becoming a very serious matter indeed, and those who are charged with the maintenance of the service are now required to take extraordinary measures to avoid as far as is humanly possible such a happening.

Because of the importance of preventing interruptions, and of the number of channels involved, open routes are gradually giving way to cables, but because of the great distances in this country open wires are likely to remain for many years to come.

Subscribers' Lines.—An important recent development was the introduction of star quad cable in 1935 to replace multiple twin. Star quad is cheaper in actual cost and also enables savings to be effected in ducts and other costs, because it takes up less space. 1400 pairs of $6\frac{1}{2}$ lb. can be contained in a $2\frac{3}{4}$ " sheath as against 1000 pairs of multiple twin. The innovation has brought with it, however, the need for capacitance balancing, which was not previously required for subscribers' cables.

Distribution methods have been improved considerably in our service during recent years. Increased flexibility has been provided by the use of distribution pillars, and a further advance has been the use of small armoured cable for leading-in purposes.

Ducts.—Many kinds of ducts have been tried, but in recent years we have concentrated on the

use of single and multi-way ducts of the self-aligning type, with the joints closed by a plastic bitumen seal. This allows some movement of ducts after they are laid without causing a fracture of the seal.

When dealing with "Transmission," reference was made to trunk cables, particularly the Bass Strait cable and the Melbourne-Geelong and Sydney-Maitland cables. Current works include the provision of cables which will be completed this year between Melbourne and Seymour, and Adelaide and Gawler. Recent practice is to use armoured cable, laid directly in the ground by machine methods. The Geelong and Gawler cables employ loading, but the Seymour and Maitland cables will depend upon repeaters.

A new development is the application of a gas-pressure alarm system to the Sydney-Maitland cables. There may be eventually as many as 408 circuits in these cables, and the idea of the alarm system is to give timely warning of an incipient fault in the sheath. Dry air is used for the alarm system, with a maximum pressure of 10 lb. per sq. inch. Methods have been developed for sectionalising, sealing, alarm facilities, and fault detection.

The trend of development will be to provide additional trunk cables as circumstances permit. In Australia there is only 5 per cent. of the trunk mileage in cable, whereas Great Britain has 90 per cent. and U.S.A. has 82 per cent., but the long distances between centres of population and density of open wire routes, as well as the capital expenditure involved, will continue to be controlling factors in the extension of trunk cables in this country.

In Open Wire Construction, recent practice has tended more to the improvement of existing methods than to the introduction of new ideas. For some years past it has become necessary in transposing lines to fix the distances between transposition poles accurately. There is now need for much greater accuracy, and margins which could be tolerated formerly in many cases, cannot now be allowed. When it was necessary to provide only for voice-frequency circuits (up to 3000 cycles), a typical pair combination with suitable transpositions had a crosstalk value of 86 db measured at 2000 cycles. This is well over the permissible figure 60 db. The same combination at 30,000 cycles has a crosstalk value as low as 32 db. This will give an idea of the change in the open wire construction due to recent developments. Transpositions per mile are of the order of 2 for voice-frequency circuits, 6 to 8 for 3-channel systems up to 30,000 cycles and 12 to 16 for 12-channel systems up to 140,000 cycles.

Besides an improvement in existing methods necessitated by new developments, there are also some recent developments in line construction methods. Fig. 8 shows the pole group at Goul-

burn junction, i.e., the junction between the Goulburn loop and the main route. Originally there was only one pole and the maze of fittings may be imagined. Now the wires in each direction have their own terminal pole; the loop consists of two trunk cables which are protected at this junction; and wires suitable for 12-

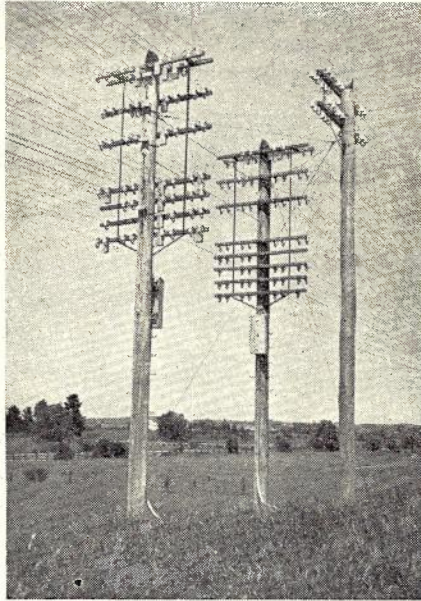

Fig. 8.—Typical "Y" Pole Arrangement.

channel working remain open and are wired neatly across the Y poles at the junction, taken down the loop and back again. In addition, there are protected retards on the poles, to block stray current effects from the high level side of the 12-channel circuits.

Submarine Cables.—Reference has been made to the Bass Strait cable, which was our major development in recent years in this type of construction. The total length is 160 miles and it has been described in Vol. 1, page 70. Of recent interest was the under-water inspection of sections near King Island. Some miles of the cable were inspected on the sea floor by a diver, and having regard to the severe ocean conditions and the amount of information obtained, together with the length of cable inspected, the work is probably unique in submarine cable practice. Reference has been made to this work in Vol. 3, page 17, but it may be added that the Department acted upon the information gained by this inspection in deciding to repair and not to incur the cost of a major deviation, which would have involved the sacrifice of the extra channels to be provided shortly.

Mechanical Aids.—There have been a number of recent developments in the use of mechanical aids to line construction. Apart from improved devices for boring crossarms, erecting poles, removing poles, cutting crossarm slots, and so

on, the most interesting developments have been the devices which are now used in laying long-distance cables.

Bucket type excavators, the ordinary furrow plough, special ripper and grubber ploughs, the mole plough, the roto-tiller (Fig. 9), and special trench ploughs have been used. This equipment has been operated by horse teams, caterpillar and other types of tractors, steam traction engines and lorry mounted machines; the choice depends upon the size of the job and the type of ground. The most satisfactory method for large installations so far is found to be the combination of a special ripper plough and caterpillar tractor, which break up a track and clear



Fig. 9.—The Roto-Tiller.

obstructions for the mole plough to follow—the mole plough being drawn by the caterpillar tractor; and for laying conduit, either the Barber Greene bucket excavator or the roto-tiller. Improved methods for cable installation include the drawing of the cable into the conduits, direct from the cable drum trailer, using a power winch.

RADIO

General.—As a result of the rapid growth of radio during the last fifteen years, this form of communication is now one of the most important among the Department's interests. Radio within the Commonwealth differs from telephone, telegraph and mail services, because a number of parties other than the Post Office actually operate radio systems. The Department thus finds itself concerned with two aspects: firstly, the regulatory side, and secondly, in certain branches of radio it is concerned as an operator.

As a regulatory body, the Department has a responsibility in regard to all radio transmitters which are operated in the Commonwealth by other parties; it assigns frequencies (wavelengths) and in this respect it must act to preserve order amongst the numerous operating

services. These services are now many and varied, including coastal and shipping, broadcasting, Civil Aviation, Defence services, police, forestry, ambulance, etc. The Department's responsibility for these services makes it necessary to measure regularly the operating fre-

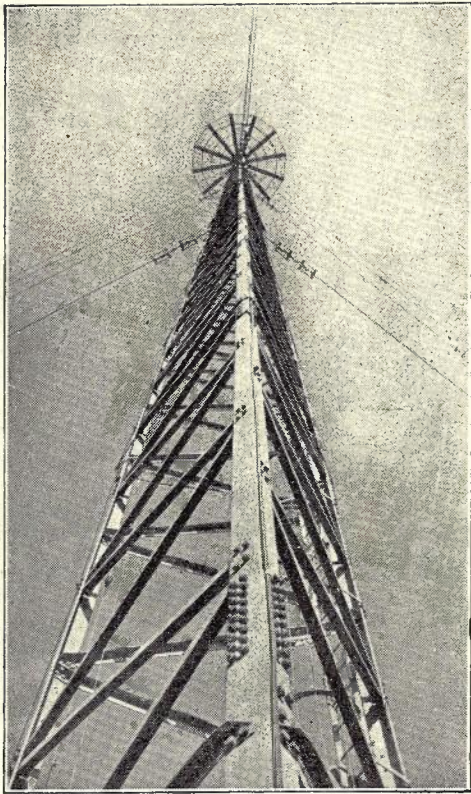

Fig. 10.—Loaded Radiator.

quency of the transmitters and those which deviate from their assigned frequencies are promptly informed so that interference may be avoided.

Broadcasting.—The broadcasting services are of special interest because two independent systems are operating. The technical services of the National system, both for the transmitting stations and the studios, are provided by the Post Office, while stations of the Commercial group are privately owned and operated. These latter stations are licensed by the Department in regard to operating power, frequency and site, while the Department also exercises a general supervision over the class of programme matter which is transmitted. As indicated earlier in this paper, the number of National Stations has increased from eight to 28 in the last ten years, whilst the number of Commercial stations has increased from 23 to 100.

The National stations form part of a system which was planned in 1929 to give stable reception for more than 90 per cent. of the population of the Commonwealth, and in developing this

plan careful attention has been given to technical improvements so that the stations will provide the best performance that can be obtained from the money invested. Improvements have been chiefly in the direction of widening the band of frequencies transmitted, lowering the noise level in the transmitted signal, and increasing the area of fading-free service. This last-mentioned factor is of great importance, and is watched carefully when the site for a station is being chosen. It is also the reason for the high radia-

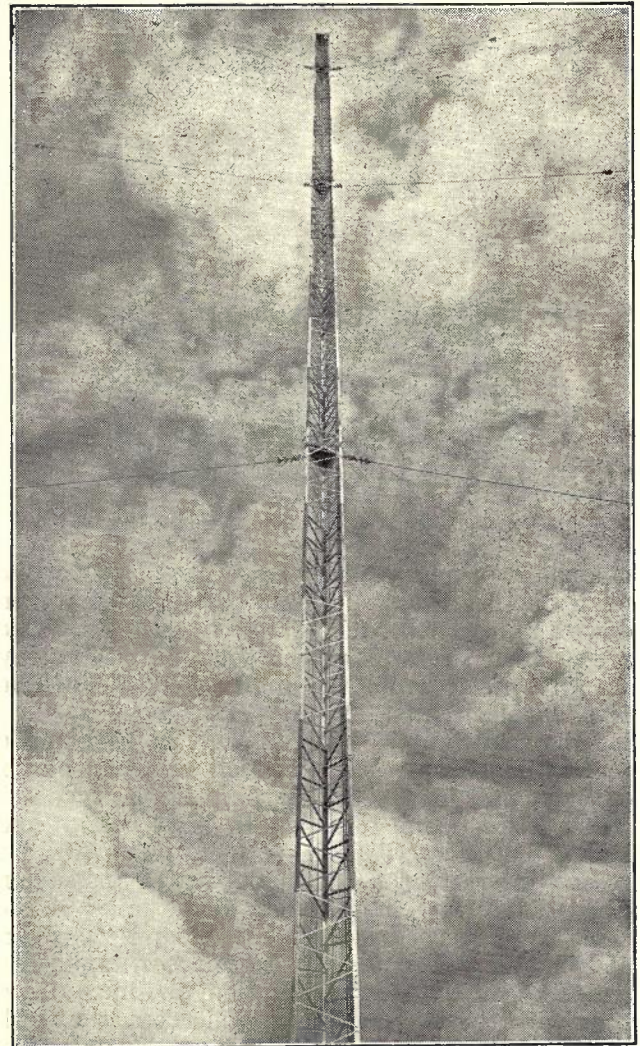

Fig. 11.—Vertical Radiator for 3LO and 3AR.

tors now in use at many of the National stations, and in this connection two developments of special interest may be mentioned. First, there is the loaded radiator—a high structure, of some 650 ft. in the case of Station 3WV, surmounted by a metal armature or disc. This type of radiator is expensive because of the structural problems, but it equals in performance a structure of considerably greater height in which the armature top is not provided. The second

innovation is to be found at the Sydenham station, where the 3LO and 3AR transmitters both operate on the one radiator, 710 ft. high. This is made possible by means of a specially designed coupling network, and it has resulted in a saving of the cost of one radiator. These weigh 45 tons and cost over £7000. Fig. 10 shows a loaded radiator. The top is 60 ft. diameter, steel, covered with wire netting, and carefully bonded throughout. Fig. 11 shows a vertical radiator, which is not loaded.

The broadcasting services operate in the medium frequency band, i.e., between 550 and 1500 kilocycles, and they cannot provide a broadcasting service over the whole of the Commonwealth because of the enormous distances to be covered. Some other means is necessary to

radio communication in the telephone and telegraph services of the Post Office is increasing. Very high frequencies above 30,000 kC., frequently called ultra-high frequency, are particularly useful for short-wave telephone and telegraph links, and during the last twelve months an experimental telephone channel has been operating in this band between Victoria and Tasmania as an added facility to the principal means of communication on this route, viz., the submarine cable. A similar type of service is operating between Townsville and Magnetic Island, Queensland, while another is now being installed between Flinders Island and Tasmania. Fig. 12 is a pictorial representation of the Townsville-Magnetic Island service. The low power and the simple equipment necessary on

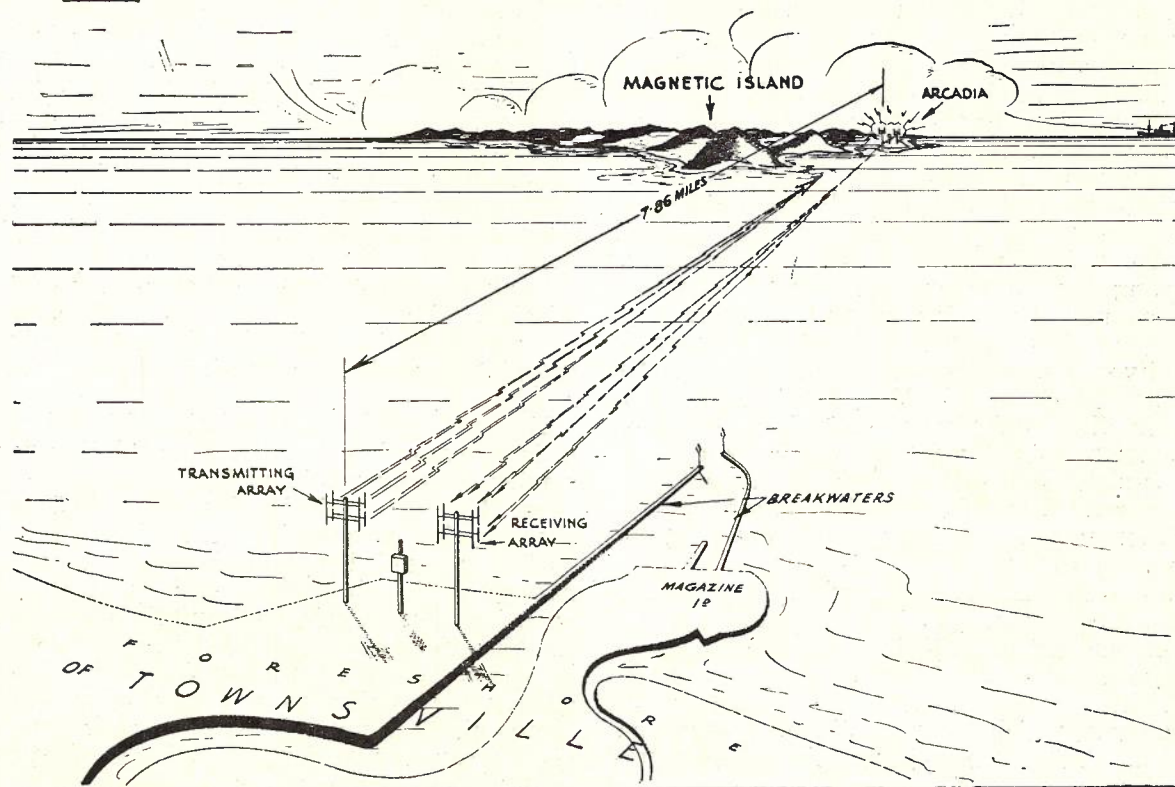

Fig. 12.—Townsville-Magnetic Island Radio Telephone and Telegraph Service.

serve those people in the remote areas of Central and North Australia, and for this reason short-wave services have been introduced using VLR, Melbourne, and VLW, Perth. By using the special properties of the band of frequencies 6-20 megacycles, a service can be given to people in the Northern and Western parts of the continent from stations conveniently located at centres such as Melbourne and Perth. These stations are now being used to give also an overseas broadcasting service for the Department of Information, which is designed to supplement the B.B.C. service, particularly in countries bordering the Pacific Ocean.

Point to Point Services.—The importance of

these frequencies make for economy in cases where the cost of a wire line connection would be prohibitive, and sometimes quite impracticable. It is expected that the system will be applied to other cases.

Radio telephone trunk service will shortly be provided to Darwin by the Sydney-Darwin link, using Civil Aviation Department transmitters and receivers located close to these centres and operating in the band 6-20 megacycles, in conjunction with our voice-operated terminals at Sydney and Darwin.

Overseas Radio Telephone Services are radio trunk services linking our internal trunk system with the international radio trunk telephone

services. Prior to the war these were operating to Great Britain, New Zealand, Dutch East Indies, Rabaul, and U.S.A. For the time being, the services to Great Britain and New Zealand have been closed down, but the other services are still operating. The radio services operate in the band 6-20 megacycles, where characteristics of the transmission phenomena make the technical problem quite complex and also relatively expensive. One requirement of overseas radio telephone service is that of secrecy. This is provided by inverting the speech currents about a frequency of 3000 cycles and, in addition, causing the transmitter frequency to vary continuously over a narrow band of frequencies.

Overseas Developments.—The trends overseas give an indication of possible future developments, among which television, radio diffusion and radio facsimile are important at present. These innovations are carefully studied, and it is useful to remember that, although the main development may not have present application here, some incidental feature may prove of great value. Television furnishes an interesting example of this. A careful study has been made of the possibility of introducing television in Australia and this has given rise to doubts concerning the value or necessity of television in the community at the present time; and, of course, the cost of the system at present is prohibitive to a country such as Australia. On the other hand, one incidental development is found in the methods of relaying television programmes both by radio and by wire line. It is possible that such wide band transmission systems may later find an important field of application in the trunk telephone system of the Commonwealth.

Radio diffusion, a system of distributing entertainment programmes by wire lines, is not used in our service. It is mainly a European development, brought about by conditions where insufficient radio channels are available for all the nations which require them. Wire distribution, also, ensures interference-free reception, gives a greater measure of control over the matter which listeners receive, and can be less costly to the listener than normal radio reception. This system does not appear to be of great importance to Australia at present.

Radio facsimile is an American development, whereby the radio receiver produces a printed page. It may yet prove a valuable adjunct to the sound broadcasting system, by allowing the transmission of sketches or diagrams and also by relieving the sound system of the need for transmitting statistical information, such as stock reports, river gauges, etc.

Frequency Modulation. — A recent advance in the radio field has been the development of the process of modulation known as "Frequency Modulation." The pioneering work in this was done by Major E. H. Armstrong in the U.S.A.,

and the success of the later stages of his work has drawn much attention to this method of modulation.

The distinction between the normal method of modulating a carrier known as "amplitude modulation" (abbreviated AM) and the process by which frequency modulation (FM) is accomplished may be briefly stated as follows:—

In AM the carrier **frequency** is held constant; its **amplitude** is varied from the mean value in direct proportion to the modulating voltage and at a rate equal to the modulating frequency.

In FM the carrier **amplitude** is held constant; its **frequency** is varied from the mean value in direct proportion to the modulating voltage and at a rate equal to the modulating frequency.

In amplitude modulation, the transmission of the two sidebands representing the modulated output occupies a total band width of twice that of the modulating band; that is, if the audio-frequency band width to be transmitted is 10 kC, then the modulated carrier will require 20 kC total width for its transmission. But in frequency modulation the band occupied by the modulated carrier must be at least five times this amount to maintain equal quality of transmission. Therefore, to transmit an audio-frequency band width of 10 kC the total band width occupied by the modulating carrier will be 100 kC.

Because of the characteristics of tuned circuits it is necessary in frequency modulation for the carrier frequency to be at least 100 times greater than the double sideband width. This means that carrier frequencies of at least 10 megacycles are needed, but because of the congested nature of the channel allocations at these frequencies, there would be insufficient accommodation for frequency modulated transmissions. The combined result of these factors is that frequency modulation as a means of present-day communication must be conducted in the ultra high frequency region; that is, at frequencies of 40 megacycles or more.

The reasons for the advance and development of frequency modulation are due to the very favourable signal to noise ratios that can be obtained. The improvement is of the order of 20 to 30 decibels over amplitude modulation in otherwise equal circumstances. Recent work has indicated, however, that this great noise advantage of frequency modulation is not maintained at all values of received field strength. It appears to vanish quite suddenly at some point in the weak field region and thereafter amplitude modulation shows an advantage. Since the conditions of ultra high frequency transmission, however, always pre-suppose a pathway that is very nearly optical in character, there are many service conditions where frequency modulation is likely to offer important advantages.

Programme Transmission.—An important adjunct to broadcasting is the provision of programme channels from pick-up points to studio and to transmitter, relays from station to station and at times extensive chain broadcasts. The programme transmission channels are provided both by wire circuits with a band width of 5000 cycles or by programme carrier circuits with a band width of 8000 cycles. The programme carrier channels occupy a position in the frequency spectrum from 34 to 42.5 kilocycles and can, therefore, be given on lines on which 3-channel carrier systems are already installed.

Some idea of the requirements for such transmission can be gathered from the fact that in 1930 some 2000 relays were given over our circuits, whereas in 1940 this had increased to 24,000. In recent chain broadcasts, which have involved 125 of the broadcasting stations in Australia, 26,000 miles of trunk channels are necessary, for which 150 engineering officers are required to be in attendance. Such statistics as these indicate how inappropriate is the term "Wireless" to this form of communication.

THE TELEGRAPH SERVICE

General.—In this, the oldest branch of the service, outstanding developments have been mainly in three directions:

1. Provision of telegraph channels by carrier systems.
2. Machine telegraph equipment, particularly of the direct printing type.
3. Telephoning of telegrams.

Carrier Systems.—The application of carrier to telegraphy began in 1926 by the installation of the Sydney-Melbourne "type B" system using frequencies up to 10 kilocycles and capable of providing 10 duplex channels. Subsequently, all the capital cities except Hobart were linked together with systems of this type. The later development is the voice-frequency system which employs a frequency band 200-3000 cycles in width. Where the circuit is a physical one, i.e., a 2-wire circuit, nine duplex channels may be obtained. On the other hand, for a 4-wire circuit, such as a carrier circuit, 18 duplex channels may be derived. As an example of the facilities which may be provided by v.f. carrier systems, it is mentioned that it would be possible to derive as many as 281 full duplex telegraph circuits on an open wire physical pair, say, between Sydney and Melbourne, should such ever be required.

Voice-frequency telegraph systems are in use between Sydney and Canberra, Tamworth and Wagga, Brisbane and Townsville, Melbourne and Launceston, Perth and Kalgoorlie. **Recent developments** include a 2-frequency single channel system in the experimental stages. This employs one frequency for marking and one for spacing, but uses up twice as much of the available frequency width as a single frequency

system. Another development is the 4-channel "super-voice-frequency" system for installation on lines not requiring a programme physical circuit, i.e., it uses the band between voice and carrier. Experiments are also in progress with a view to operating the "type B" carrier telegraph system over a carrier telephone channel, thereby releasing the physical circuit for a 3-channel carrier telephone system if required. The use of carrier in the telegraph service has brought about the provision of many extra circuits at very much less cost than the erection of physical wires and in general with much greater freedom from interruption.

Machine Telegraphs.—Of the 17,000,000 telegrams handled annually in the Commonwealth, 57 per cent. is transmitted per medium of automatic direct page printing machines. Some idea of the development in this direction may be obtained from the fact that 628 channel ends of machine systems are now in use, compared with 251 in 1926.

As part of this development there has been a great increase in the number of single channel printing machines or teleprinters. This is a direct page printing device with typewriter keyboard. Over 300 such machines are in service at present, representing a capital investment of \$48,000. The leased services cover a variety of types, such as private point to point local services, long-distance services — particularly for defence purposes — printergram services and special multi-transmission weather networks. Recent developments in the field have been largely in the direction of extending existing facilities and for these Creed teleprinters have been most used.

Telephoning of Telegrams.—Although to some extent a competitor to the telegraph service, the telephone is used very extensively in dealing with telegrams at some point in the telegraph system. Phonograms, as these telephoned telegrams are called, increased from 5,000,000 in 1931 to 10,000,000 in 1939. Special positions are provided in all capital cities to receive these messages. At Melbourne, for instance, there were 14 operators in 1930; now there are 24. Ancillary working to improve the speed of answer is provided on these positions. In Melbourne, 28 per cent. of the traffic originating in the C.T.O. and branch offices is received by telephone.

An important auxiliary in large telegraph offices is that of conveying telegrams direct from point to point per medium of conveyor belts and pneumatic tubes. These are now provided in all the larger offices and greatly assist in reducing office lag. More recent developments include new types of belt systems in which several novel features are being exploited.

Picturegram Service. — Picture transmission between Sydney and Melbourne was introduced in 1929 by the installation of the Siemens-

Karolus system, operating over a carrier channel. Due no doubt to the speedy air-mail service now provided between these two cities, there has not been any appreciable increase of business during the period under review.

ASSOCIATED SERVICES

A survey such as this would hardly be complete without some reference to the developments which have taken place in services associated with the major activities.

In these days of mechanisation, motor transport forms a valuable adjunct in service provision and maintenance. In all, the Post Office owns over 1100 vehicles, some three-quarters of which are exclusively used for engineering work. The annual running and repair bill, apart from depreciation and interest charges, is £100,000 in round figures.

In staffing and educational activities, the organisation has been expanded and in recent years particular attention is being given to training.

Some other services which have not been referred to previously include sound recording methods for giving verbal announcements in the telephone service, such as "time," "engaged lines" and "disconnected lines." The onset of the war has caused a temporary suspension of our plans for developing these services. It is of some interest in this connection to note that in both U.S.A. and Sweden this form of service has been extended to include weather forecasting.

Conclusion

In a paper read at a time like this it is inevitable that the war should receive some, if only

brief, mention. The demands upon the resources of the Department by the Defence Services have been great and pressing, and the load has fallen particularly heavily upon the technical services of our Department. We may take justifiable pride in the fact that our resources so far have been equal to the demands made upon them—whether those demands have been for communication services, for personnel, for technical assistance in the design of equipments, for the building of prototype equipments, for the procuring of supplies or for the complete execution of defence works.

The story of the part played by the Post Office in this war, however, even thus far, is one the telling of which will have to be left until a later date, when the war is won and tales may be told without breach of censorship conditions or violating the bonds of secrecy now imposed upon us. But although the story may not yet be told, we may claim that there is no reason for the Post Office to feel ashamed of the part it is playing in the war effort of the Nation. I, personally, am very proud of it.

But quite apart from those particular duties already entrusted to us, we have the general responsibility of maintaining communications in whatever circumstances war may bring to our shores. So far we have been fortunate enough not to have been required to maintain our services under active service conditions, but we must be prepared for whatever call is made upon us. I need not dwell upon the importance of communications in such circumstances, or the heavy responsibilities that devolve upon our technical forces. I feel confident you will not be found wanting.

MEASURING INSTRUMENTS

A. A. Lorimer, M.E.E. A.M.I.E.(Aust.)

Introduction. — A study of all measuring instruments would fill many volumes as the development of type, range and precision of measurement has progressed hand in hand with the growth of modern scientific knowledge. To anyone engaged in communication engineering, electrical instruments are, without doubt, of the greatest interest, for there is probably no other branch of engineering where a wider range of instrument is used and a greater variety of measurement necessary.

The tremendous strides that have been made both in knowledge and in the successful application of this knowledge in modern telecommunication systems have been made possible only by the allied development of an ever-increasing variety of instruments to measure new properties, to cover wider ranges than before, and to give results to a degree of precision previously unknown. These requirements naturally result

in many highly specialised instruments, but in spite of—or, it might be more correct to say, "because of"—the increasing complexity of many measurements and measuring circuits the simple measurements of current and potential have retained their positions of importance, for no others are more commonly made or have wider applications. Even in the majority of complex measuring instruments or testing equipment the ultimate measurement usually consists of reading the indication given by some current or potential meter and interpreting that indication in terms of some desired unit.

For this reason it will be appreciated that a thorough understanding of the simple basic instruments used for current and potential measurement forms the foundation on which practically all electrical measurements depend. Of these two it will be appropriate to consider first the current meters as the principle on which the

majority of potential meters operate depends on the measurement of current rather than of potential.

CURRENT MEASURING INSTRUMENTS

Many types of instrument have been developed for the measurement of current. Some have fallen into dis-use and are now only of historical interest, having been superseded by new and better methods; others have continued in use in very much their original form, but with continual improvements and refinements resulting from the development of more suitable materials and from practical experience and increased knowledge of measuring technique. The two principal divisions into which the measurements fall are the measurement of direct current (D.C.) and the measurement of alternating current (A.C.). Some instruments are used exclusively for one type of measurement, some for the other, while some are suitable for either. A description of the general features of the well-known types of instrument might well be given.

MOVING MAGNET INSTRUMENT

This was possibly the earliest form of instrument for the accurate measurement of D.C. It depended on the measurement of the deflection of a suspended or pivotted permanent magnet by the electro-magnetic field from a fixed coil carrying the current. In an early but sensitive type it will be remembered in the form of the tangent galvanometer; in a more recent form it will still be familiar to many as the Q-I detector. For all practical purposes, this type of instrument has been superseded by the superior type, depending not on the movement of a magnet in the field of a fixed coil, but on the movement of a coil in the field of a permanent magnet—the well-known permanent magnet moving coil instrument.

MOVING COIL INSTRUMENT

(a) **Principle and Description.**—This type of instrument holds pride of place for precision, sensitivity, reliability and flexibility in D.C. measurements. Generally, it consists of a light coil pivotted between jewel bearings and mounted in a cylindrical space between the poles of a permanent magnet. A central core of soft iron or a suitable alloy is also mounted to leave only an annular air gap with just sufficient clearance to permit the coil to rotate freely in the concentrated magnetized field. The restoring torque—opposing the twist or rotation of the coil—is produced by helical control springs which serve also to carry the current into one end and out from the other end of the coil.

In the extreme sensitive case, using the moving coil principle, i.e., the D.C. reflecting galvanometer, the coil instead of being pivotted is

suspended by a long metallic ligament or suspension which also serves to conduct the current in and dispenses with the spiral control springs, thus giving a much weaker controlling force and hence a much more sensitive instrument.

In an intermediate type the suspended coil is just supported on one pivot to steady it without introducing too much pivot friction. This produces an instrument with characteristics intermediate between those of the pivotted instrument and the suspended type. In yet another, and fairly common type—the uni-pivot type—the weight of the coil is taken on one pivot and one main spiral control spring serves not only to supply the restoring torque, but keeps the coil “lined up” and dispenses with the top pivot to keep it in position. This last type achieves a greater sensitivity than the usual double pivotted type, but as the coil is not rigidly centred between pivots the pointer is more free to oscillate slightly and the instrument is not so convenient to use. However, as the general characteristics are almost identical with those of the more commonly known and more frequently used double pivot instrument, subsequent remarks will be confined to the latter.

(b) **Characteristics.**—The principal characteristics of the moving coil instrument can be summarised as:

(i) **Suitability for D.C. Only.** The magnetic field across the air gap is uni-directional and hence a uni-directional current—i.e., D.C.—is necessary to produce a rotation of the moving coil. A.C. will tend to produce deflections in opposite directions during alternate half cycles of current. A frequency of a few cycles per second will produce a corresponding beat or oscillation of the pointer, but as the frequency increases the inertia of the moving system will make it increasingly difficult to follow and the vibration of the pointer will become gradually smaller until finally no movement at all will be detected. This characteristic enables the instrument to measure accurately a D.C. quantity even though a decided ripple or A.C. component is also present.

(ii) **Sensitivity and Range.** Sensitivity can be controlled over a wide range by selection of the number of turns in the coil, the strength of the restoring torque in the control springs, the strength of the magnetic field, and the amount of shunting used to by-pass some of the current. With the modern magnets and with very fine control springs, instruments can be made, giving full scale deflection with a few microamps. By shunting the current through an alternative path and allowing only a small portion to go through the moving coil the range can be built up to many thousands of amperes.

(iii) **Linearity of Scale.** By using the annular air gap the flux distribution is kept uniform and so the deflecting torque is proportional to the

current in the coil. This torque is balanced by the control spring restoring torque which is also proportional to the twist. Therefore the twist of the coil and the deflection of the pointer are proportional to the current through the coil. In other words, equal increments of current through the coil result in equal steps of pointer deflection and hence in equally spaced scale graduations. This is known as a linearly marked scale, or linear scale. Occasionally for special purposes a non-linear scale is required and then the response is deliberately changed from a linear one to the required response by some means such as shaping the pole faces to create a non-uniform field in the air gap, or by introducing some variable resistance feature into the circuit. A familiar example of this, is in some "decibel" meters where the current response of the instrument is made approximately logarithmic so that the "decibel" scale will be approximately linear.

(iv) **Accuracy.** The present-day standard of springs and magnets available for use in instruments makes the best moving coil instruments the most accurate and stable of all types. The ability to read the instrument with precision is also great because the linearity of the scale naturally lends itself to the accurate subdivision of the uniformly spaced graduations and to the accurate estimation of the pointer position between these sub-divisions. The reliability and stability of the best instruments are such that it is often guaranteed that at no point of the scale does the pointer indication differ from the correct value of current by more than 0.1% of full scale value. Even in the comparatively cheap and more commonly used "mass production" type such as small panel mounted instruments accuracies to within 1.0% of full scale value can readily be obtained.

(v) **Balance.** Balance weights are mounted on arms attached to the moving coil system and adjusted to counteract the unbalance on that system and to bring the centre of gravity into the line of the spindle or the axis between the two pivots. When this is done accurately the same response occurs and hence the same calibration holds, whether the meter is used in a horizontal, in a vertical, or in some other intermediate position.

(vi) **Sources of Error.** Many factors contribute towards the presence of errors and uncertainties in the indications given by these instruments. Some are due to imperfections in the material and in the various components used, such as, for example, gradual permanent ageing and change of characteristics of control springs and magnets and also, to a lesser extent, in the characteristics of resistor wires — temporary changes in the same components due to temperature changes either in the ambient atmosphere or to local heating in some part due to insuffi-

cient current carrying capability — changes in shunting ratios due to non-uniform temperature change or to differing temperature coefficients in various parts of the circuit—temporary changes in control spring characteristic due to fatigue or "give" through being kept under stress for extended periods—pivot friction through wear or damage to the pivot or jewel bearing. In addition, there are other causes, such as the alteration of strength of the magnetic field in the air gap due to the proximity of external magnets and magnetic fields, including the earth's field or to electro-magnetic fields from large D.C. coils or due to the shunting effect caused by neighbouring masses of magnetic material such as iron frames or the iron top of a bench on which the instrument may have been placed. These errors are seldom of appreciable magnitude.

(vii) **Methods of Adjustment.** The most commonly used means of adjusting the instrument to give the correct response are to vary the strength of the magnetic field in the air gap by an adjustable magnetic shunt across the magnet—to alter the shunting ratio (where a shunt is used across the coil) by adjusting either the resistance of the shunt or the resistance of the moving coil circuit, in which latter case the adjustment is made on a small resistor mounted in series with the coil—or to alter the length of the control spring. The latter of the three methods may possibly be the only one available in some cases, but is neither as convenient to manipulate nor as easy to adjust finely and accurately as either of the other two, being rather a "hit or miss" method, particularly when the end of the spring is not held in a clip, but is soldered and so has to be unsoldered for each adjustment.

DYNAMOMETER INSTRUMENT

(a) **Principle and Description.** This is similar to the permanent magnet moving coil instrument in that it has a moving coil pivoted as before and controlled by spiral control springs—or, in the case of a dynamometer galvanometer, a coil suspended similarly to that in the ordinary moving coil galvanometer—but it differs in that the magnetic field is produced, not by a permanent magnet, but by the field from a coil fixed alongside the moving coil and carrying the same current that passes through that coil.

(b) **Characteristics.**—This one change in the principle of operation leads to several outstanding differences in the characteristics from those of the moving coil meter.

(i) **Suitability for Both D.C. and A.C.** The coil is deflected by the electromagnetic field produced in the fixed coil by the same current that flows in the moving coil. If the direction of the current is reversed both the current in the moving coil and the field will reverse and hence the deflection will be in the same direction as before.

A current I amps. (D.C.) will produce the same deflecting torque as I amps. (A.C.) R.M.S. value, hence the instrument is suitable for A.C. as well as D.C. and forms a useful transfer standard which can be calibrated on D.C. and used with that calibration on A.C.

(ii) **Non-linearity of Scale.** The magnetic field is no longer constant, but is proportional to the current flowing through the fixed coil. If the moving coil were always in a fixed position relative to this field the deflecting torque would be proportional to the square of the current and the scale shape would follow a square law rather than a linear law. However, as the moving coil turns in the field the number of lines of force enclosed by the coil will vary and this will modify the square law. The general characteristic is a contracted scale at the zero end, becoming more open at the top end.

(iii) **Sensitivity.** This type does not lend itself to extremely sensitive ranges like the permanent magnet moving coil. The field due to the open fixed coil is not nearly as intense as that due to the permanent magnet with its small air gap and, naturally, decreases as the current is reduced. The upper range is limited by the current which the control springs can carry. For ranges above this, the moving coil can be shunted if the instrument is to be used only on D.C., or a current transformer can be used if on A.C. only.

(iv) **Frequency Range.** As the frequency increases errors due to such effects as the inductance and self-capacitance of the coils, eddy currents in the conductors or in neighbouring masses of metal, etc., become more serious and lead to increasing divergence between the D.C. and the A.C. response. In general, the useful frequency range covers the commercial range—probably to not much more than 100 cycles per sec.

(v) **Accuracy.** The dynamometer instrument can be made with an accuracy approaching that of the moving coil instrument, although the non-linearity of scale detracts from the accuracy of reading. It forms probably the most accurate transfer standard between D.C. and low frequency A.C.

(vi) **Sources of Error.** The absence of magnet and of shunts of low temperature coefficient alloys renders the dynamometer instrument free from a number of possible sources of error present in the moving coil type. It is, however, susceptible to errors due to the permanent ageing changes, or the temporary thermal or fatigue changes in the control spring characteristics—to pivot friction—to external magnetic fields of the same periodicity as that of the current in the coils—and to the presence of masses of magnetic materials.

(vii) **Methods of Adjustment.** The sensitivity can be altered by means of the control springs,

by altering the position of the coil relative to the electromagnetic field, by shunting a small portion of the current through a high resistance parallel path—or by altering the strength of the field by varying the number of turns on the fixed coil.

MOVING IRON INSTRUMENT

(a) **Principle and Description.** — The current flows through a fixed coil. In one pattern, a vane of soft iron or alloy with similar characteristics is mounted eccentrically on the pivoted spindle and is attracted by the electromagnetic field of the coil—rotating the spindle and deflecting the pointer along the scale as it moves under the influence of the field. In the other pattern, two vanes, one fixed and the other on the pivoted spindle as before, are mounted side by side in the centre of the coils' field and so, with current flowing, are magnetised in the same direction and repel each other. The moving vane in being repelled rotates the spindle as before.

(b) **Characteristics.**

(i) **Suitability for Both D.C. and A.C.** The soft iron vane will be attracted by the field and the two similarly magnetised vanes repelled by each other, irrespective of whether the field is unidirectional as caused by D.C. through the coil or reversing as caused by A.C. in the coil. Fields due to current I (D.C.) and current I R.M.S. (A.C.) will produce the same force, theoretically, and hence the meter should be equally suitable with A.C. as with D.C. This, in practice, does not strictly follow as effects due to inductance, self-capacitance, eddy currents or hysteresis in the iron vane tend to make small differences between the D.C. and A.C. response. Therefore it is not as suitable as the dynamometer instrument for use as a transfer standard between D.C. and A.C. The use on A.C. is restricted to the "commercial" range where moderate accuracy is sufficient.

(ii) **Non-linearity of Scale.** The pull or the repulsion depending on the pattern of instrument used, increases as the square of the strength of the field and hence as the square of the current—tending to produce a square law scale. This law is modified by the movement of the vane, by the change in the magnetic properties of the iron due to the different degrees of saturation, by the contour adopted for the vane and by the type of control adopted, i.e., whether spring or gravity control. In general, the scale is contracted at the low end and open at the top, although the above factors can be utilised to modify this considerably to suit special requirements.

(iii) **Sensitivity.** The instrument is rugged and simple, but not naturally sensitive as the magnetic attraction or repulsion decreases rapidly when the current is decreased, depending as it does on the second power of the current.

It lends itself to a high range as the field can be produced by a coil of a large number of turns carrying a moderately small current, or a few turns of heavy conductor carrying a large current, down to the limit of one turn of heavy copper strip which might carry some hundreds of amps.

(iv) **Spring and Gravity Control.** The restoring torque may be provided by control springs, in which case the movement can be balanced and the instrument used in either horizontal or vertical position. It may, on the other hand, depend on gravity control as the vane is moved from its equilibrium position, in which case the instrument can be used only in the one position for which it is designed.

(v) **Accuracy.** The accuracy is inferior to that of the dynamometer, particularly if the instrument is for use both on D.C. and A.C., hence it is most suitable for current indications where the tolerance of at least 1% of full scale value is allowable.

(vi) **Sources of Error.** No current has to flow in the moving system, a feature which eliminates certain sources of error present in the moving coil and dynamometer type. Errors will still be introduced due to imperfections in control springs or in pivots and jewels and to possible changes in the electromagnetic field through A.C. effects in the coil. Others, peculiar to this type of instrument, will be introduced by the rather unreliable behaviour of the iron vane which depends largely on its previous stages of magnetisation, and which also varies with temperature.

(vii) **Methods of Adjustment.** This may be done by varying the control springs, varying the number of turns on the current coil or by adjusting the position of the moving vane on the field or relative to the neighbouring fixed vane. This latter method is attended by risks of altering the shape of the response of the instrument, i.e., it may not make the same percentage change of sensitivity over the whole scale range.

THERMAL PRINCIPLE INSTRUMENTS (GENERAL)

The next type of instrument is one which operates on a different principle to the previous ones and has opened new possibilities by utilising the thermal characteristics of materials. This instrument has been developed on at least three different lines—each depending on the heating of a wire by the current to be measured, one utilising the change of resistance, a second utilising the linear expansion and the last utilising the change of temperature. In all three the principle and the design are such that alternating currents up to radio frequency will produce the same required effect as direct current of the same value, hence each can be used as a transfer instrument between D.C. and A.C. to radio fre-

quency. However, only the last-mentioned of the three is in general use to-day. The first type may be briefly mentioned here in passing. The A.C. entering at diagonal corners passes through and changes the resistance of fine wires arranged as the four arms of a bridge. The other diagonal corners balanced against the A.C. are taken to a D.C. bridge on which the change of resistance can be measured. This is an indirect way of measuring current and has not come into general use like the other two.

THE HOT WIRE INSTRUMENT

This depended on the extension of a fine wire due to heating by the current through it. This expansion was used, by a multiplying device, to produce a larger movement in the pointer attached to a pivotted spindle. It was developed in a number of forms suitable for use on D.C. or on A.C. up to radio frequency, but it was unsatisfactory in many ways—being sluggish, uncertain in the return to zero, susceptible to changes due to cooling of the wire by stray draughts and to changes of ambient temperature, insensitive, requiring a comparatively large energy consumption and being very liable to the burning out of the fine heater wire due to small overloads. It has, for all practical general use, been superseded by the thermocouple type instrument.

THERMOCOUPLE INSTRUMENT

(a) **Principle and Description.**—This type depends on the fact that a current will flow round a circuit consisting of two different metals when one of the junctions is heated relative to the other. This is due to what is called the thermoelectric EMF generated at the hot junction. In the thermocouple instrument the current to be measured is passed through a wire proportioned so as to develop the maximum heating consistent with the allowance of an overload safety factor. A thermojunction is either welded to this heater wire or cemented to it, so that an EMF is developed due to the temperature rise in the wire. This thermojunction circuit is completed through an ordinary sensitive D.C. milliammeter the scale of which is then marked, not in terms of the current through it, but in terms of the heater wire current which is the cause of the temperature rise and consequently of the thermal EMF. The portion of the circuit carrying the primary current can be kept short and compact and hence can be designed so that inductance, capacitance and skin effects are minimised and so that A.C. will produce the same heating effects as D.C. The thermocouples themselves fall into two main divisions—the vacuum type, usually used for the smaller currents (up to the order of 100 milliamp, although this limit varies with different makes), in which the fine heater wire and the junction are both enclosed in an evacuated glass

bulb and the open type exposed to the atmosphere. The vacuum type can be run at a higher temperature without oxidation and deterioration of the heater material resulting in an increased EMF and so enables the lower current limit to be extended below that which would otherwise be possible. Many different methods are used for the design of the heater and the connection of the thermojunction to it, in order to obtain greater sensitivity, or larger current range or to extend the frequency limit up to which the characteristics are reasonably similar to those on D.C.

(b) **Characteristics.**—As the final indicator is a moving coil instrument, the general characteristics include those of this type both in the general electrical features, possible sources of error and the methods of adjustment. Other features are, of course, peculiar to this type of instrument such as:

(i) **Suitability for D.C. and A.C.** As previously stated, the circuit to carry the measured current is designed to eliminate, as far as possible, effects due to inductance, capacitance, skin effect, etc., and to ensure that A.C. will produce the same heating effect in the heater wire as D.C. of the same nominal value. In many commercial instruments this is effected satisfactorily up to radio frequencies of a few megacycles, but in some well-designed types operation on A.C. giving reasonably the same calibration as on D.C. is claimed to at least 100 megacycles and for a considerable range above this corrections can be supplied which will allow for the gradual divergence between the D.C. and A.C. response. This suitability over such a wide frequency range makes the thermocouple instrument the outstanding one as a transfer instrument to be calibrated on D.C. and used with that calibration on A.C.

(ii) **Non-linearity of Scale.** The heating effect in the heater wire is proportional to the square of the current and the thermal EMF is reasonably proportional to the temperature rise at the junction, so that the spacing of the scale graduations widens as the deflection increases according to a square law.

(iii) **Sensitivity and Range.** Because of the square law relation between current and thermal EMF a reduction in current results in a much greater reduction in EMF and in the deflection of the indicator so that the instrument is not suitable for very sensitive measurements. In addition, physical limitations and need for mechanical strength put a limit to the continued reduction of cross section in the heater to obtain the necessary temperature rise with lower values of current. At the upper limit of range the heaters can be made to carry some hundreds of amps, but as the current range increases it is usually accompanied by a contraction of the useful frequency range.

(iv) **Accuracy.** Because of the combined sources of inaccuracy both in the indicating D.C. meter with its non-linear scale and in the thermocouple itself, the accuracy of this type is less than that of the corresponding moving coil linear scale instrument. An accuracy to within 0.25% of full scale might be achieved in precision instruments and possibly to within 1% or 2% of full scale in general purpose instruments.

(v) **General Characteristics.** It is sluggish in response, particularly if the heater is heavy and has a big thermal lag and also because the D.C. indicator is invariably heavily overdamped. It indicates the RMS value of the A.C. current, or, if on D.C., it records the total heating effect due both to the D.C. and also any A.C. component that may be present. It usually does not have much overload factor of safety.

(vi) **Sources of Error.** In addition to the sources of error due to imperfections in the D.C. instrument used, other errors due to thermal effects, frequency effects and to defects in the design of the thermocouple itself are present. The heater is subject to temperature fluctuations due to cooling draughts, to change in ambient temperature or possibly to conduction through the leads, while there is also a certain degree of thermal instability in the response. At the limiting frequency, errors become appreciable due to inductive and capacitance effects and, in the large current ranges, particularly with heavy cross section heaters, to the skin effect which increases the high frequency effective resistance and causes greater heating than for the same value of direct current. In the connection of the thermojunction to the heater there is also present the possibility that if used on D.C. a slight direct potential due to the two junction wires at their position of connection being not at equi-potential points on the heater, being introduced into the measuring circuit, either aiding or opposing the thermal EMF and so giving a response differing from that on A.C.

(vii) **Methods of Adjustment.** The most common method of adjusting the sensitivity is by means of a series resistor between the thermojunction and the D.C. meter, provided that the EMF is initially more than sufficient to give full scale current on the meter and hence a reduction of current by increasing the resistance in this circuit is possible. Alternatively, any of the methods already cited as applicable to a moving coil instrument can be applied to adjust the sensitivity of the D.C. meter to the current which can be supplied by the thermal EMF. Failing this, the sensitivity of the thermocouple itself can be adjusted—increased by scraping the surface of the heater slightly to decrease the cross section and so increase the heating, or decreased by shunting a small portion of the current through a shunt of the same material as the heater.

(To be completed in Vol. 3, No. 4.)

SPEECH POWER, VOLUME INDICATORS AND THE NEW VOLUME UNIT (VU)

E. P. Wright, B.Sc.

Introduction.—It is the intention of this article to discuss the methods whereby the magnitude, intensity or amplitude of telephone and programme transmission over wire lines is measured. At the same time there will be indicated recent developments in such methods.

We are all aware of the three values of a sine wave by which its magnitude may be expressed, namely, the average, the r.m.s. and the peak values. These values also apply to complex non-sinusoidal periodic waves met with in various phases in engineering. In electrical communication, waves are not only very complex but, in general, non-periodic. This follows naturally from the variable nature of speech or music and all are no doubt familiar with the irregular outline of oscillograms of such currents on telephone lines. To give some idea of their magnitude, a fourth "value" is desirable for such waves and has been called "volume." Volume is a purely empirical quantity which, however, meets a very practical need. It is simply the reading of an instrument, known as a volume indicator, with particular dynamic and electrical characteristics, the calibration of which instrument is laid down and which has to be read in a specified manner.

Perhaps the most important use of volume indicators is for the prevention of audible distortion in programme transmission. They are, however, used in several other ways and for completeness, all will be scheduled below:—

(a) As an indication of a suitable level at a particular point to avoid audible distortion in line amplifying, radio and other equipment.

(b) As a means of providing a continuous check at a number of points of the transmission losses or gains in an extended programme network.

(c) To enable the loudness of programmes when finally reproduced to be pre-determined.

(d) To prevent damage or interruption by overload as may occur in radio transmitters or sound recording systems.

(e) To indicate volume at a certain point to ensure proper operation of so-called vodas equipment on radio telephone links.

(f) To carry out sine wave transmission measurements.

Until quite recently many organizations produced their own volume indicators. They were of different electrical and dynamic characteristics, were calibrated on different bases and generally were not directly related to one another. Early in 1938 the Bell Telephone Laboratories of America in association with the Columbia Broadcasting System and the National Broadcasting

Company reviewed this whole question with a view to some standardization, at least within their own organizations. The findings and decisions of this general development were briefly as follows:—

(a) A reference level or reference volume for all these types of measurements was agreed upon.

(b) A new unit—the volume unit (vu)—has been adopted for expressing magnitude of the quantity "volume."

(c) A new type of volume indicator has been standardized, the characteristics of which are rigidly specified.

Reference Volume.—In order to make practical use of the volume indicator, a reference volume or zero volume level must be established to which

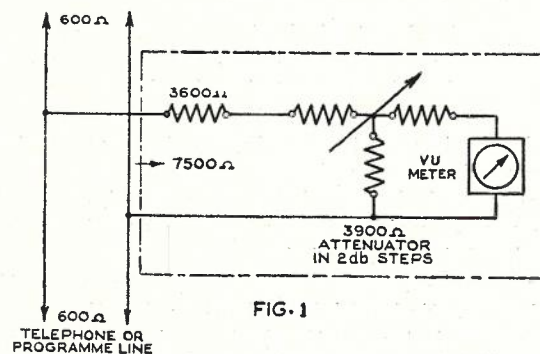

FIG. 1

the readings have to be referred and, in addition, a method of taking such readings must be prescribed. In the same way as "volume" itself, is an empirical though definitely practical quantity, so also is "reference volume." A suitable definition of reference volume is—that level of programme which causes a standard indicator when calibrated and used in the accepted way to read to some defined mark on the scale: in this case 0 vu or 100.

The connection between "reference volume" and "calibrating power" lies in the fact that both use the same scale mark. They are, however, quite different quantities. Calibration is effected by a steady single frequency tone (1000 cycles) applied to the volume indicator and gives a steady reading at the scale mark. Volume is measured on a programme line by adjusting the associated and integral attenuator (Fig. 1) until the meter pointer reaches the same scale mark but only once every 10 secs. with occasional over swings. From this it will be realized that there will be peaks many times the calibrating power but most of the time the level will be only a fraction of the calibrating power. With the attenuator adjusted so that the meter reads 0 vu, the programme level with respect to "reference volume"

is read directly in vu from the calibration of the attenuator.

Most are familiar with the fact that many different reference volumes or reference levels have, in the past, been in use for specifying the magnitude of speech and program waves such as:—

1 mW, 6 mW (5.9), 10 mW, 12.5 mW, 50 mW. All these values originally had their own significance. 1 mW is familiar as output to line from 3B and 6A transmission measuring sets. The 6 mW (5.9 value seems to have arisen from that fact that it was approximately the volume delivered over a short subscriber's loop by the standard telephone set then in use when spoken into with a fairly loud voice. Those who were in early, on the installation of the type B carrier telephone system will remember 10 mW as a standard figure for carrier power to line. The "reference volume" decided upon in the American development was that volume which would cause the standard volume indicator to read 0 vu when calibrated, i.e., to read 0 vu, by 1 mW of 1000 cycle power in a 600 ohm resistance.

The Volume Unit (vu)

Having standardized on a calibrating power and the corresponding "Reference Volume," there is need for a unit to measure volume in respect to "Reference." To this end a new unit has been adopted, namely, the "Volume Unit" (vu). It is like the decibel (db) in one respect, namely that numerically, a particular signal will be the same number of volume units (vu) different in magnitude to some other signal as it is in decibels (db). It is different, however, in that vu only requires a + or — sign with it to completely fix it and thereby is, in a sense, a semi-absolute measurement. db are not so and are either only a relative measurement or else require some further statement to establish their real magnitude. In a sentence—"The volume level in vu is numerically equal to the db relationship between the level under consideration and 'Reference Volume.'" In using the volume indicator it is desirable as far as possible to adjust the attenuator until the meter deflects to the 0 vu point as indicated previously. This will not always be practicable, particularly in the case of low volumes. The volume then becomes the algebraic sum of the readings of the attenuator (marked in vu) and of the meter deflection, and always includes the resultant + or — sign.

The Volume Indicator

The various types of volume indicators which have been used up to date fall, in general, into two classes:—(a) the "r.m.s." type; (b) the "peak" type. These terms, "r.m.s." and "peak," strictly, are only relative, the peak integrating the speech waves over a shorter period of time than the "r.m.s." indicator. For true peak values a device like the cathode ray oscillograph

would be necessary. In general, the "r.m.s." indicator is less complicated. Exhaustive tests which were made between these two types of instrument indicated that the peak type had no outstanding advantages from a measurement point of view over the r.m.s. type. There were, on the other hand, the following reasons why the standardization of an r.m.s. indicator would be desirable. The form of r.m.s. indicator is a copper oxide rectifier meter and with the development of these types over recent years, models of sufficient sensitivity without the use of electron tubes have become available. They cost less, they may be made rugged and portable, and require no power supply.

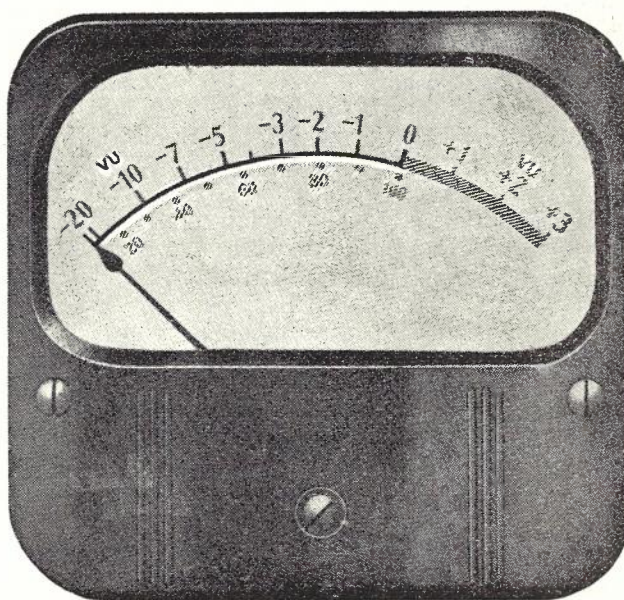

Fig. 2.

The meter itself is a full wave copper oxide rectifier type, the development of which was carried out by the Weston Electrical Instrument Corporation in association with the bodies mentioned previously. Photographs of two models of these instruments appear as Figs. 2 and 3 of this article. From these the following points will be noticed. There are two scales marked on each, a vu scale and a 100 or % scale. According to the requirements of the job, so one or other is made the more prominent as shown. More will be said about this later. The dynamic and electrical characteristics of this instrument will now be considered. These are very important in view of the fact that the quantity being measured—volume—is quite arbitrary and is definitely bound up with the response of the meter.

The dynamic characteristics decided upon were as follows:—

For a 1000 cycle voltage of such magnitude as to give a steady reading of 100 (arbitrary value on the voltage scale, see Fig. 3) the pointer

should read 99 in 0.3 second and should then over-swing the 100 point by at least 1.0 and not more than 1.5%.

The electrical characteristics are bound up with an associated circuit as shown in Fig. 1. The copper oxide meter is itself of 3900 ohms impedance, hence the attenuator of this value. This attenuator looks back to an impedance of 3900 ohms towards the line made up of 3600 ohms fixed resistance and 300 ohms from the two line impedances in parallel. This is necessary to give correct loss through the attenuator as in practice it is the reading of the attenuator which gives the "volume" at the measurement point. The 3600 ohms fixed resistance also ensures the proper dynamic characteristics of the meter. The total impedance of the meter and associated circuit is 7500 ohms, which makes it high enough to be bridged across the line as a monitoring device without appreciable loss. It was mentioned earlier that the complete volume-indicator is required to read 0 vu with 1 mW of 1000 cycles power in a 600 ohm resistance. Actually the sensitivity of the meter itself is insufficient for the needle to deflect to the 0 vu point when connected to that calibrating power but will only reach -4 vu. This is taken care of by marking the zero position of the attenuator as +4 vu. Adding, therefore, the reading of the attenuator to the reading of the meter, gives a nett of 0 vu. The attenuator has eleven steps of 2 db and on one particular model is designated +4 to +26. The extremes of reading of the complete volume indicator would therefore be approximately—

$$\begin{array}{l} \text{Meter Atten.} \\ -10 + 4 = -6 \text{ vu} \\ \text{to} \\ +3 + 26 = +29 \text{ vu} \end{array}$$

It is of some interest to refer again to Figs. 2 and 3. In Fig. 2 the prominent scale is that of vu and in telephone and programme line work is likely to be the more important. The 100 scale is used with broadcasting stations where the main requirement is to load up the radio transmitter to the 100% modulation mark and as well to see that it is not overloaded. Much consideration has been given to these scales with a view to making them easy to read. Firstly, the scale itself is large, much more extended than several of the earlier types. There is a continuous line running across the face of the instrument by which it is easier for the eye to follow the pointer movements. All but absolutely essential inscriptions are removed from the face of the instrument. The scale of importance in the particular use is the bolder. The 0 vu or 100 mark is at a point 70% from the beginning of the scale which has been found by experiment to be the most suitable position for operation, bearing in mind desirable length of scale and overswings.

In addition to the several requirements of the volume indicator mentioned heretofore, there

are certain other characteristics which it is required to meet. The more important of them are as follow:—

Response vs. Frequency.—The sensitivity of the volume indicator instrument shall not depart from that at 1000 cycles by more than 0.2 db between 35 and 10,000 cycles per second nor more than 0.5 db between 25 and 16,000 cycles per second.

Harmonic Distortion.—The harmonic distortion introduced in a 600 ohm circuit by bridging the volume indicator across it is less than that equivalent to 0.2 per cent. (r.m.s.).

Overload.—The instrument is capable of withstanding, without injury or effect on calibration,

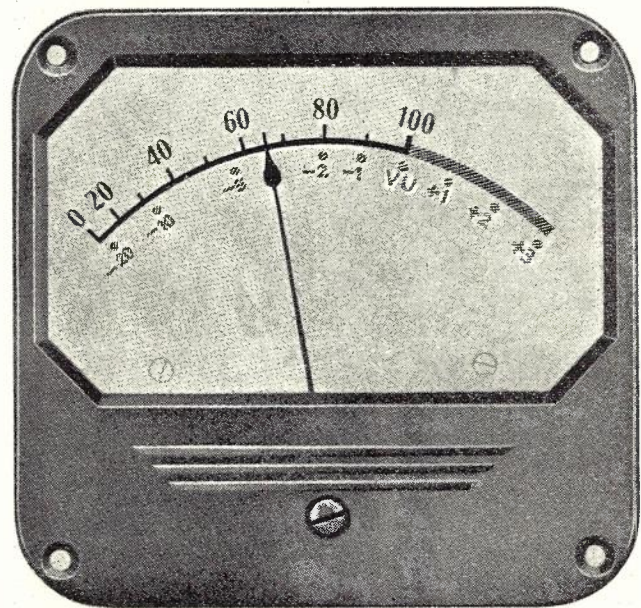

Fig. 3.

peaks of 10 times the voltage equivalent to a deflection to the 0 vu or 100 mark for 0.5 second and a continuous overload of 5 times the same voltage.

Presence of Magnetic Material.—Powerful magnets have been used in this instrument, hence it is essential to mount it wherever possible on non-magnetic panels. Where panels not more than 1/16th in. in thickness are used, it is satisfactory to cut out a hole approximately to the size of the meter front.

Temperature Effects.—In the instruments now available, the deviation of the sensitivity with temperature is less than 0.1 decibel for temperatures between 50° F. and 120° F., and is less than 0.5 decibel for temperatures as low as 32° F.

Conclusion.—An attempt has been made to describe the new volume reference which has been adopted by the Bell System of America in association with prominent broadcasting companies, together with the development of a sensitive inexpensive volume indicator. In addition,

volumes of speech and program circuits may now be expressed in semi-absolute terms by the new unit, the vu. For further information on this matter, reference should be made to the following articles:—

(1) A New Standard Volume Indicator and Reference Level—H. A. Chinn, D. K. Gannett and R. M. Morris—Bell System Technical Journal, January, 1940, pp. 94-137.

(2) The "Vu" and the New Volume Indicator—S. Brand, Bell Laboratories Record, June, 1940, pp. 310-314.

Up to the present none of the complete volume indicators have been purchased for use in Australia. However, a small number of the copper oxide meters having the vu scale prominent, were obtained recently by the Research Laboratories.

MR. C. McHENRY, A.M.I.E.(Aust.)

With deep regret we record that after an illness of several months Mr. C. McHenry, Assistant Supervising Engineer, Chief Engineer's Branch, died on 8th March, 1941. Officially and personally, we have suffered an irreparable loss. His work as a Telephone Engineer has had a



considerable influence on the progress and standards adopted by the Department. His contributions to the literature on the subject have been acclaimed universally. His genial personality and genuine friendliness will be missed by his many friends and associates.

In 1913, Mr. McHenry joined the Department as a Mechanic in Sydney and, as he was a natural student, in 1917 passed the Engineers' Examination. At the Sydney Technical College he conducted classes in Telephone and Telegraph Engineering and, at a later stage, he lectured on Telephone Transmission at the Victorian Postal Institute. He had a flair for Mathematics and applied this to his work in many original ways,

including the statistical treatment of telephone traffic. An article written by him on this subject was published in the British Post Office Electrical Engineers' Journal as early as 1921. He was regarded as one of the leading authorities on this subject.

In 1925, he was transferred to the Chief Engineer's Branch and since that time he has been associated with the major developments in telephone equipment. His services were made available to the Victorian Railways to assist them in the design of their telephone service. Later, he was called upon to assist them in a study of the circuits and systems of operation for high tension supervisory control.

He was particularly adept at circuit design and many ingenious circuits will long remain a monument to his ability. He was one of the first to realise the possibilities of automatic trunk exchanges and was intimately associated with the design of the new Melbourne Trunk Exchange. In connection with this work, he was sent to England in 1938 to advise the contractor in respect to our requirements and to deal with the difficulties arising during the course of the detailed design and manufacture of the equipment. To complete his studies of the latest practices in automatic trunk switchboards, he returned via America with a detour by air clipper to Sao Paulo, Brazil.

Mr. McHenry was a keen and enthusiastic member of this Society. His advice was often sought by the editors of this Journal, and his ready assistance was always both helpful and encouraging. His many direct contributions to the publications of the Society are well known, and before the onset of his illness he commenced a series of articles on the Melbourne Trunk Exchange.

His wide technical knowledge was outstanding. It was always a pleasure to discuss problems with him because, in his own happy manner, he invariably supplied inspiration and guidance. Mr. McHenry will long be remembered for his unobtrusiveness and helpful friendliness, quite apart from his considerable technical achievements. We tender our sincere sympathy to Mrs. McHenry and family in their great loss.

DRAWER TYPE NON-SWITCHING UNITS

E. J. Bulte, B.Sc.

The non-switching unit is one of the earliest forms of telephone switchboard and is a simple and convenient method of enabling a business man to utilise one telephone for connection to several circuits, such as an exchange line, a

service, were housed in a wooden cabinet which was installed either on the office table of the executive for whom the service was provided or on a small adjacent table. Thus the unit absorbed valuable table space, and in modern offices it did not harmonise with the office furniture and equipment.

In an endeavour to overcome these disadvantages, a drawer type unit has been developed and has proved popular. The subscriber is re-

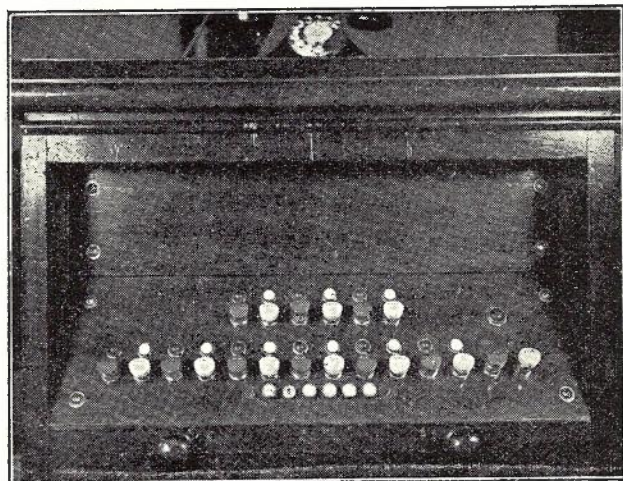

Fig. 1.—Drawer Unit with Sloping Key Panel.

P.B.X. line, and direct lines to other executives of the firm. The apparatus is called a non-switching unit because it is not designed to provide



Fig. 2.—Drawer Unit with Vertical Key Panel.

switching facilities for intercommunication between lines connected to the unit. For many years the keys, indicators, etc., required for the

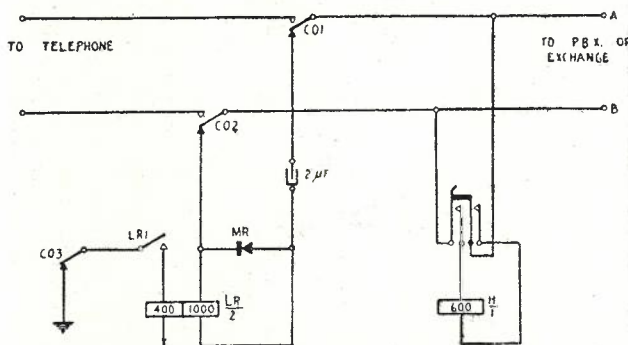
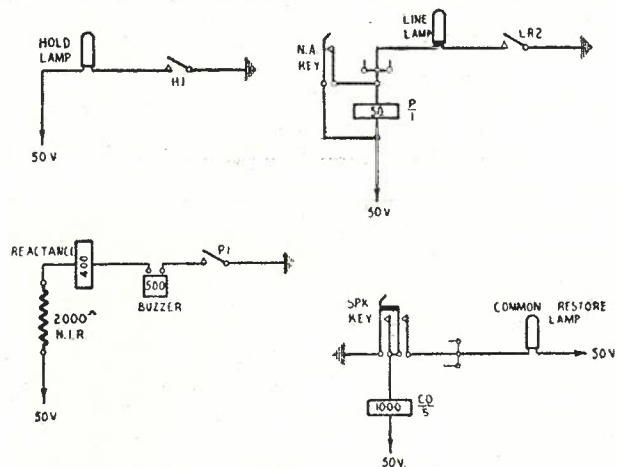

Fig. 3.—Exchange Line Circuit.

requested to make a drawer of his table available for the telephone equipment. It is transported to the Workshops and all the keys, relays, lamps, etc., required for the service are mounted therein and wired to a terminal block in the drawer. It will be noted from Figs. 1 and 2 that lamps are used instead of indicators for calling signals and Ericsson type press keys operated in the reverse manner to the usual way are used instead of lever keys.

Although the examples illustrated show the left-hand drawer being used, in later cases the right-hand one has been favoured as being more convenient to manipulate by a right-handed person. The designations of the keys "N.A." and "B.C.O." have been altered to "Buzzer" and "Power" in later units, as being more explanatory to the lay mind.

Facilities which have been provided on the units are as below:—

- (1) Line, exchange, P.B.X. or P.A.B.X., with speak and hold keys.
- (2) Line, exchange, P.B.X. or P.A.B.X., filtered by a clerk or secretary.
- (3) In conjunction with facility (2), a guard circuit is available, if required, to indicate to the secretary, and others, if desired, that the "Chief" is engaged in a telephone conversation.
- (4) Two-way direct line with combined speak and call keys.

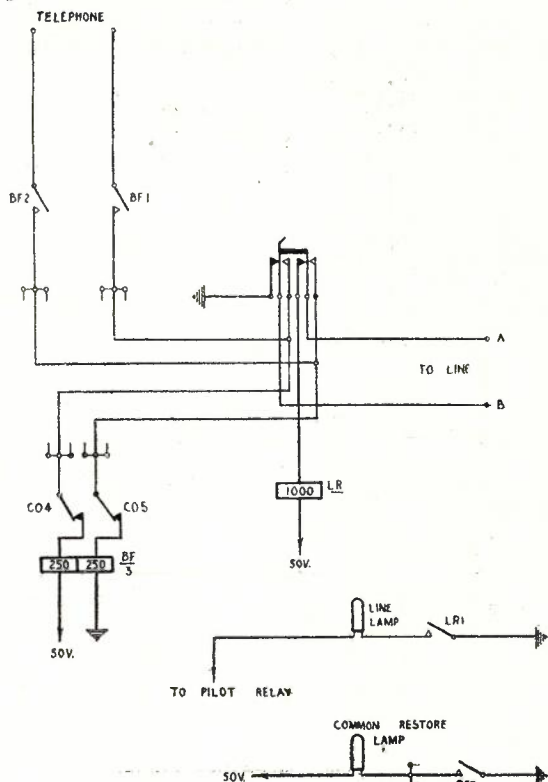

Fig. 4.—Direct Line—Two Way, Battery Feed End.

(5) One-way direct line, with a combined speak and call key at the calling end, and a speak key at the called end.

(6) Press buttons for buzzers to messenger, typist, etc., can conveniently be incorporated in the drawer front.

Figs. 3 to 7, inclusive, cover typical circuits for the non-switching units. The operation of these circuits is as described hereunder:—

Fig. 1.—Exchange or P.B.X. Line Circuit

The line is connected to terminals A and B and ringing current operates relay LR via contacts CO1 and CO2. The metal rectifier MR serves to hold the relay operated during the ringing pulses, that is, the relay is slow release. If the service is from an automatic exchange or a P.A.B.X., relay LR is single wound, and it will operate regularly during the standard interrupted ringing periods. Where manual ring is

used, the double wound relay is employed, and, on operation, LR locks via contact LR1. The lamp circuit is completed by LR2.

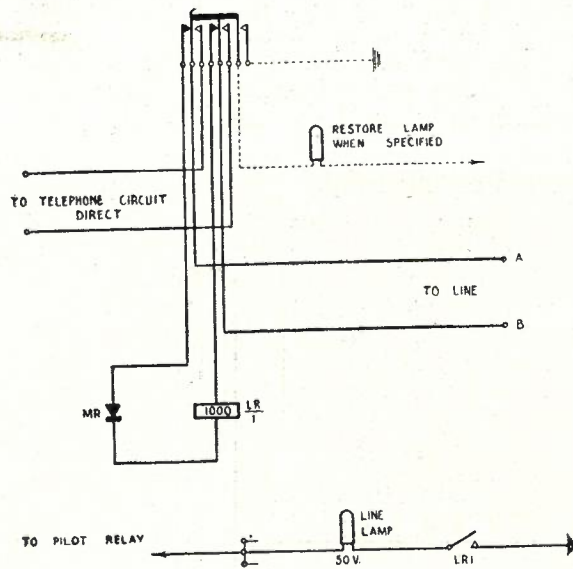

Fig. 5.—Direct Line—Two Way, Rectifier End.

When the speak key is operated, relay CO is energised.

CO1 and 2 disconnect the 1000 ohm winding of LR and extend the incoming line to the telephone.

CO3 opens the locking winding of relay LR, which releases and opens the line lamp circuit.

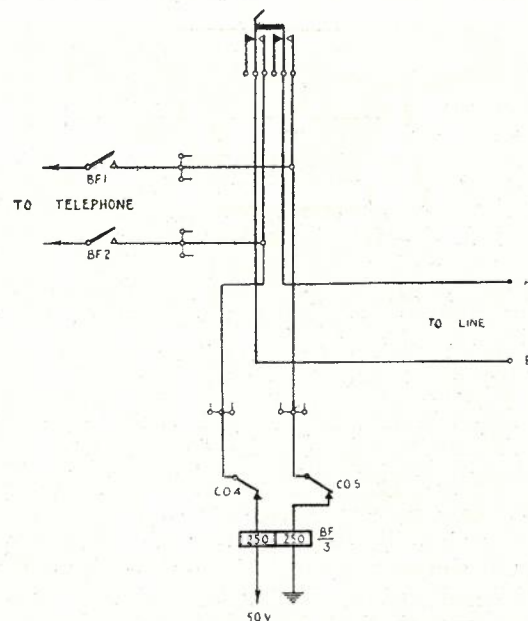

Fig. 6.—Direct Line—One Way, Outgoing End.

CO4 and 5 (shown in Fig. 4) disconnect battery from direct line circuits so that exchange and local batteries will not be in opposition if two keys are operated simultaneously.

When the hold key is operated, relay H is

connected across the incoming line and operates. The circuit for the hold lamp is completed via H1.

Figs. 4 and 5.—2-Way Direct Line Circuits

When both keys are normal, rectifier MR prevents the operation of relay LR in each circuit. If the key at the battery feed end (Fig. 4) is depressed, the reversal of polarity of the battery will operate relay LR at the rectifier end and so light the calling lamp.

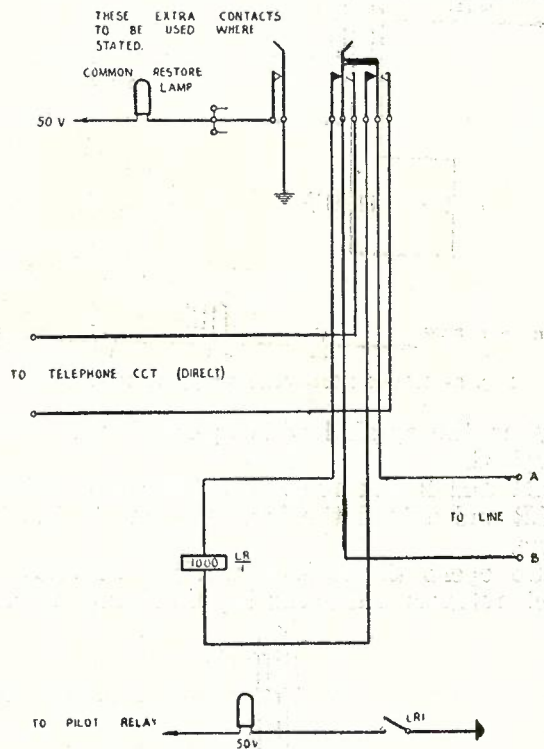

Fig. 7.—Direct Line—One Way, Incoming End.

If the key at the rectifier end (Fig. 5) is depressed, the telephone loop will operate relay LR at the battery feed end (Fig. 4) and the line lamp will light.

With both keys operated, speaking conditions are set up with the battery feed via relay BF (Fig. 4). Contacts BF1 and 2 connect the telephone to line at the battery feed end.

Fig. 6 shows a circuit for the outgoing end of a one-way direct line, whilst the incoming end is shown in Fig. 7. The operation is similar to that described for Figs. 4 and 5, except that one-way signalling only is provided.

Fig. 8 shows the special call filter circuit. The complete circuit is similar to that described for Fig. 3, except that an additional relay F has been provided, and there is an extra contact on relay CO. Normally the incoming ring is diverted via contacts F1 and F2 to another unit or tele-

phone, so that the call may be challenged by a subordinate officer. The operation of the speak key energises relays CO and F. Contacts F1 and F2 disconnect the filter circuit and the call is then connected to the executive.

On Figs. 3 to 8 a common restore lamp is shown. This lamp is provided on the larger units to indicate to the operator that a key is off normal and should be restored when a conversation is completed. Other circuits, such as (1) a special guard circuit in which a lamp situated in an adjoining room or passage is wired so that it will light when the executive is engaged on a telephone call and so guard against intrusion, and (2) changeover circuits for

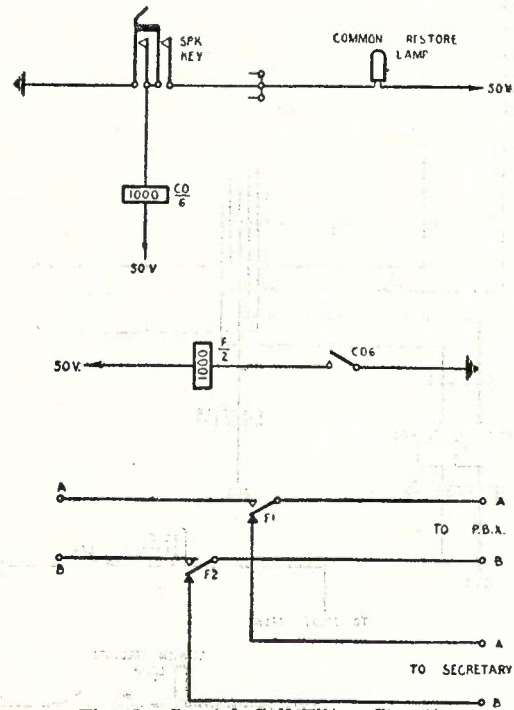

Fig. 8.—Special Call-Filter Circuit.

switching lines from the executive to his secretary, have not been included as they are relatively simple.

Conclusion.—The units installed to date have given very little trouble from a maintenance point of view, with the exception of breakdown of the rectifier units in the two-way direct line circuit. These rectifiers were originally of the 1/12A type, but it was found that with the continued application of a D.C. reverse voltage the rectifiers often broke down after a period owing to uneven distribution of the 50 volts over the individual discs. It has, therefore, been necessary to increase the series discs to 18 in lieu of 12 to overcome the trouble, and no further faults of this nature have since been encountered.

INTERCOMMUNICATION TELEPHONES TYPES A.5 AND A.10

A. R. Gourley, A.M.I.E.(Aust.)

In Vol. 1, No. 5, page 249, Mr. A. Brookes, of Ericsson Telephones Ltd., England, described the Intercommunication Telephones, which were introduced in Australia in 1938.

The A.5 system provides for one exchange and five extension lines, whilst the A.10 system is designed for two exchange and 10 extension lines. These telephones have proved very satisfactory in service, but, as a result of experience, some modifications have been made and apparatus ordered under Schedules C.2271 and C.2424 for new installations will differ in some respects from that in use. When compared with systems in service, the main differences are:—

(1) The telephones will be connected in "series" instead of in "parallel" and junction boxes will not be used.

(2) Transfer units for services with internal extensions only have been designed for wall mounting, and on all transfer units the switching arrangements for connecting a second main station have been deleted.

(3) On A.10 systems with an external extension a new transfer unit, No. 3A, has been designed to replace transfer units Nos. 2 and 3.

The apparatus required for the main types of intercommunication services is:—

- (1) **A.5 service with five internal extensions.**
5 telephones, intercom., No. 1.
1 transfer unit No. 1B.
- (2) **A.5 service with four internal and one external extensions.**
4 telephones, intercom., No. 1.
1 handset telephone, No. 332 (or similar).
1 transfer unit No. 1A.
- (3) **A.10 service with 10 internal extensions.**
10 telephones, intercom., No. 2.
1 transfer unit No. 2A.
- (4) **A.10 service with nine internal and one external extensions.**
9 telephones, intercom., No. 2.
1 handset telephone, No. 332 (or similar).
1 transfer unit No. 3A.

Telephones, Intercommunication, Nos. 1 and 2.

—In appearance, the telephones are similar to those in service, but the instrument cord is terminated on a terminal strip mounted in a wooden case (see Fig. 1) in which the buzzer is fitted also. The instrument cord is 4 ft. 6 ins. long and the conductors are terminated on spade terminals to provide for ready connection to the terminal posts. To facilitate packing, the terminal box is supplied disconnected from the cord. The terminal box replaces the plug and jack used with

each telephone now in service. The variations to the circuits are:—

(1) A 150 ohm resistance, YC, is wired in the buzzer circuit, but normally it is short circuited. If the voltage of the battery supply at a subscriber's premises is between 28 V. and 40 V., the strap should be cut.

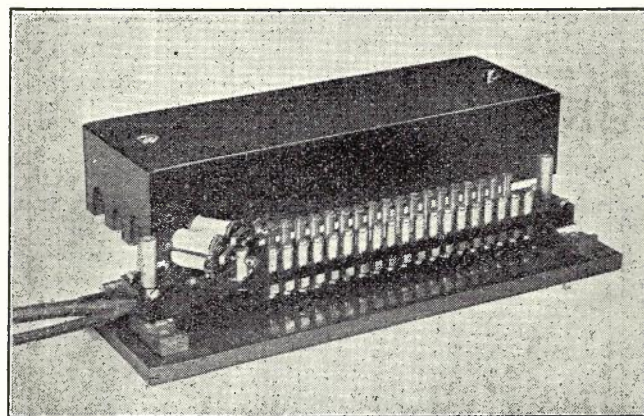

Fig. 1.—Typical Terminal Box for Intercom. Telephones Nos. 1 or 2.

(2) "CM" terminals can be fitted to provide for extensions calling the main station, whilst the latter is holding an exchange call.

(3) The connections of the instrument cord are shown for connection to either a plug or a terminal box.

The circuit of an A.10 telephone is shown in Fig. 6.

Transfer Units.—Transfer units Nos. 1 and 2 were designed for table mounting, but as the switching operations performed on these units are infrequent, the allocation of space on a table is not essential, therefore wall mounting units have been designed and Nos. 1B and 2A now replace units Nos. 1 and 2 respectively. As shown in Fig. 2, the units are housed in wooden cases of similar type to those used for extension switches.

Transfer unit No. 1A is used for switching one exchange and one external extension line and the original designation stands. Transfer unit No. 3A is used for two exchange and one external extension lines and replaces transfer units Nos. 2 and 3. As frequent switching operations may be necessary on these units, the original design for table mounting has been retained.

The facility for transfer to a second main station has been deleted because, under service conditions, it was found that an extension bell wired from the transfer unit to a location adjacent to the alternate extension for answering

calls from the exchange and external extension, met requirements satisfactorily.

Transfer units are installed in a position adjacent to the main station telephone. Units Nos. 1B and 2A are cabled to the terminal box associated with the main station telephone, whilst for Units Nos. 1A and 3A a cord is supplied for connection to the terminal box. Fig. 7 covers the schematic circuit of Units Nos. 1B and 2A, whilst Fig. 8 shows the circuit for Units 1A and 3A. Except that keys have not been provided for connecting to a second main station, the only circuit

the transfer unit are terminated on the main station terminal box. The multiple cable also commences from this box and is connected to the boxes of other telephones in "series," i.e., at telephone No. 2 the cable from No. 1 is led in and another cable is led out to telephone No. 3. At each telephone the relative in and out wires for each circuit are connected to the same terminal, i.e., the telephone connection is teed off the multiple cable; thus the term "series" is not strictly correct, but it is used to differentiate between this method of cabling and the "parallel" method in which up to three telephones are teed off the

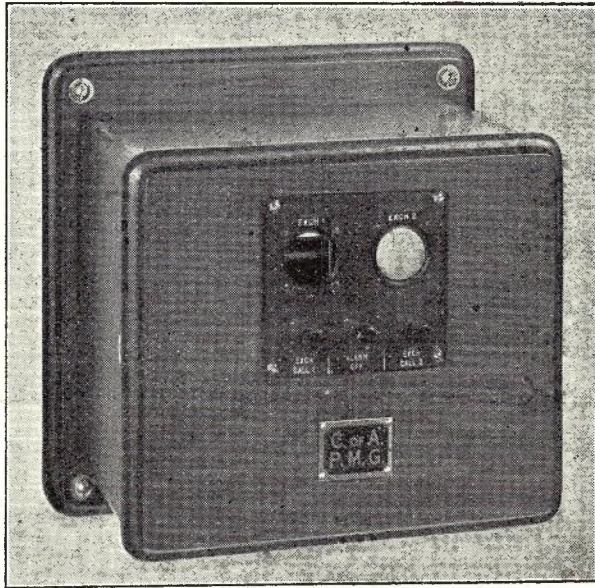

Fig. 2.—Unit, Transfer, Intercom. No. 2A.

modification is in respect to units Nos. 1A and 3A (Fig. 8). In the battery feed to relays BZ and QR a 50 ohm resistance YC is wired, but is normally short circuited. When the battery voltage at the subscriber's premises is between 28 V. and 40 V. the strap across YC should be cut.

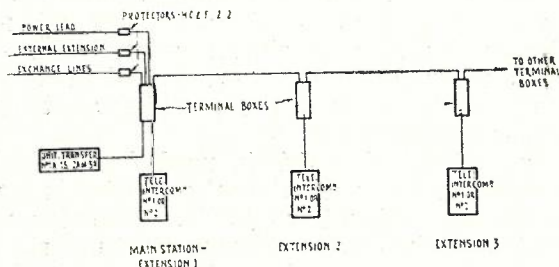

Fig. 3.—Typical Layout for Intercom. Telephones with Terminal Boxes.

Method of Cabling and Terminal Box Connections.—The general method of cabling is shown in Fig. 3. To ensure that the minimum length of cable is used, it is essential to plan the layout carefully. The power lead, exchange and external extension lines and the cord or cable from

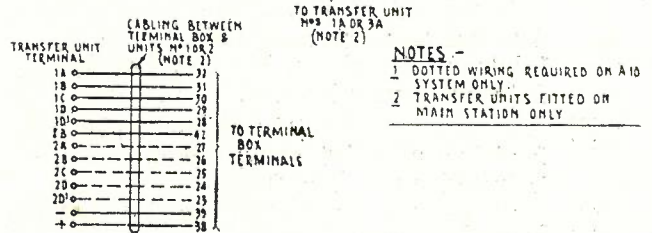
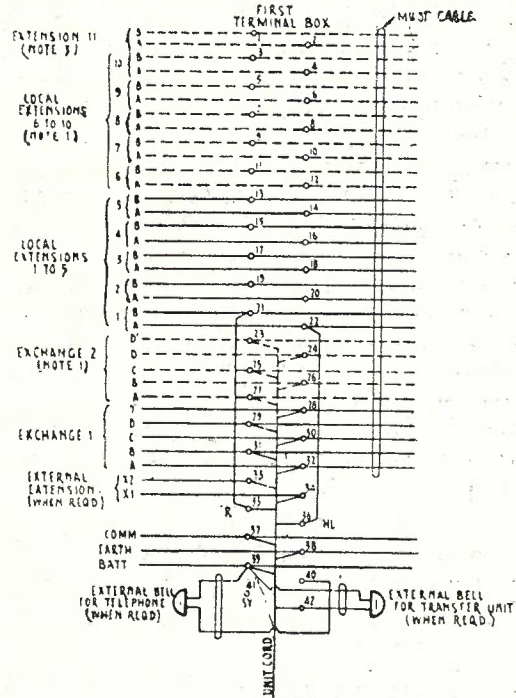

Fig. 4.—Terminal Box Connections.

multiple cable from each junction box. The sizes of multiple cable used are 15 pr. tw./10 switchboard, L.C. for an A.5 system and 20 pr. tw./10 switchboard L.C. for an A.10 system.

The terminal boxes associated with A.10 telephones are fully equipped with 42 terminals, but boxes associated with A.5 telephones are fitted with 27 terminals only, although the same strip moulding and moulding numbering are used. The cord connections are in the same relative position on each type. Fig. 4 shows the connections for a typical terminal box for both A.5 and A.10 systems. The connections shown in full line are

- NOTES—
- 1 DOTTED WIRING REQUIRED ON A10 SYSTEM ONLY.
 - 2 TRANSFER UNITS FITTED ON MAIN STATION ONLY.

those required for an A.5 system, whilst the connections shown in broken line are required in addition to those shown in full line to provide for an A.10 system.

The cord from the telephone and from transfer unit No. 1A or 3A should be connected on the underside of the terminal strip, whilst multiple cables and cable from transfer unit No. 1B or 2A should be terminated on the front of the terminal strip. Transfer units are connected to the main station terminal strip only.

At each telephone the "HL" and "R" wires should be connected to the multiple pair corresponding to the extension number of the instrument. Switchboard wire should be used for this purpose.

When a 6th extension on an A.5 system or an 11th extension to an A.10 system is required, they are connected to terminals 11 and 12 and 1 and 2 respectively. The strapping arrangements are shown in Fig 5. On an A.10 system, on telephones 1-10, the relative "A" and "B" terminals are strapped to terminals 1 and 2 and the multiple cable wires which would connect normally to the "A" and "B" terminals of each

should be connected direct to the "A" and "B" terminals.

If an external extension is connected to an A.5 system with six extensions, or an A.10 system with 11 extensions, the "R" and "HL" terminals are in use—see Fig. 5—but if extension bells are not required, terminals 40 and 42 can be used for "R" and "HL" leads for the external extension. When this modification is necessary, the terminals should be designated specially. This congestion will occur in the main station terminal box only, and then only, in cases in which all facilities are required.

When an extension is barred exchange service, for each exchange line, the "C" conductor in the instrument cord should be connected to earth (terminal 38), whilst the other exchange line conductors should be insulated and not connected to the terminal strip.

When it is desired to bar an extension from making exchange calls except under the control of the main station, the "D" conductors from the telephone should be connected to the "D1" terminals (Nos. 28 and 23) in the terminal box and not the "D" terminals.

Circuit Operation

The circuit operation is generally similar to that of the telephones described in Vol. 1, page 249, but to cover minor variations the following description is furnished. These comments refer to the A.10 system, but apply equally to the A.5 system.

Local Calls Between Internal Extensions (Fig. 6).—To call another internal extension the caller removes the handset, thereby allowing the HM springs to operate, and fully depresses the local key of the required extension, thereby operating springs CB and L. Earth is extended via HM2, CB2 and the appropriate L2 springs to the B line of the called extension. HM1 and HM2 prepare a circuit for the transmission bridge. CB1 extends the buzzer to the common wire. HM3 and HM4 have no function at this stage.

If the called extension is free, the earth placed on the B line is extended to the R wire of the called extension and thence via 1H3, 2H3, HM1 and the buzzer to battery. (Note.—At each telephone the A and B common wires in the local cable are jumpered to the HL and R terminals respectively.) The called extension buzzer is actuated for the period during which the caller has the appropriate local key fully depressed.

The called extension answers by removing the handset from its rest. The HM springs operate and the telephone circuit is connected to the HL and R wires via 1X3, 2X3, and 1X2, 2X2, HM1, 2H3 and 1H3 respectively. Battery and earth are fed to line through transmission bridge RA.

When the caller's finger is removed from the local key, the latter partially restores to the "speaking" position. The L springs remain operated, but the CB spring bank is released. The

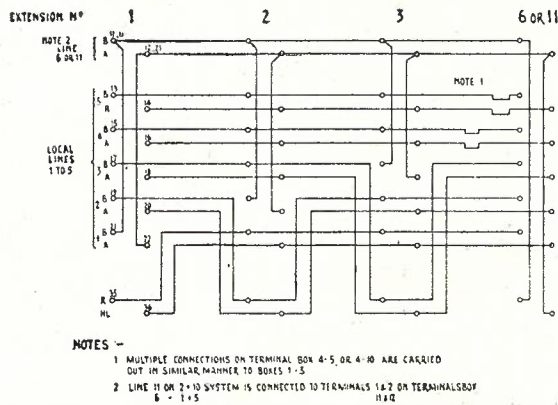

Fig. 5.—Terminal Box Connections for 6 or 11 Extensions.

telephone are connected to the "R" and "HL" terminals. On extension 11 the multiple cable is straight and terminals 1 and 2 are strapped to the "R" and "HL" terminals respectively. A similar arrangement is adopted for an A.5 system except that connections are made to terminals 11 and 12 instead of 1 and 2. Apart from these modifications, the connections are as shown in Fig. 4.

When an external extension is connected, the line wires are terminated on terminals 33 and 34 of the main station terminal box. The cord from unit, transfer, No. 1A or 3A is connected to these terminals also. The "R" and "HL" conductors in the transfer unit are connected to terminals 35 and 36 and these terminals are strapped to the "A" and "B" terminals of the extension number allotted to the external extension. A typical strapping is shown in Fig. 4. The main station "A" and "B" conductors should be insulated and tied back and the "HL" and "R" conductors

telephone circuit is connected to the A and B lines via the appropriate L1 and L2 springs and so to the called extension telephone. Battery and earth for transmission is fed via the RA coils at both stations on this class of call.

If the called extension is engaged on a call to another extension, the earth on the R wire incoming from the calling extension will not operate the buzzer at the called extension as the buzzer circuit is disconnected at HM1. When the local key on the calling telephone is released to the "speaking" position, the telephone circuit is connected to the A and B wires. Thus, a caller

Internal Extension Calling External Extension (Fig. 8).—When the calling extension lifts the handset and fully depresses the appropriate local key, an earth is extended to the B line. The earth is received on the R wire of the external extension circuit and thence via KX4, L3-4-5, BZ25-24, BZ150 to battery, with a parallel circuit via coil of relay H to battery. Relays H and BZ operate. H1-2 short circuit relay Q, whilst H3-4 and 21-22 prepare for the extension of the A and B lines. H23-24 disconnect the extension indicator.

Relay BZ in operating breaks its own circuit

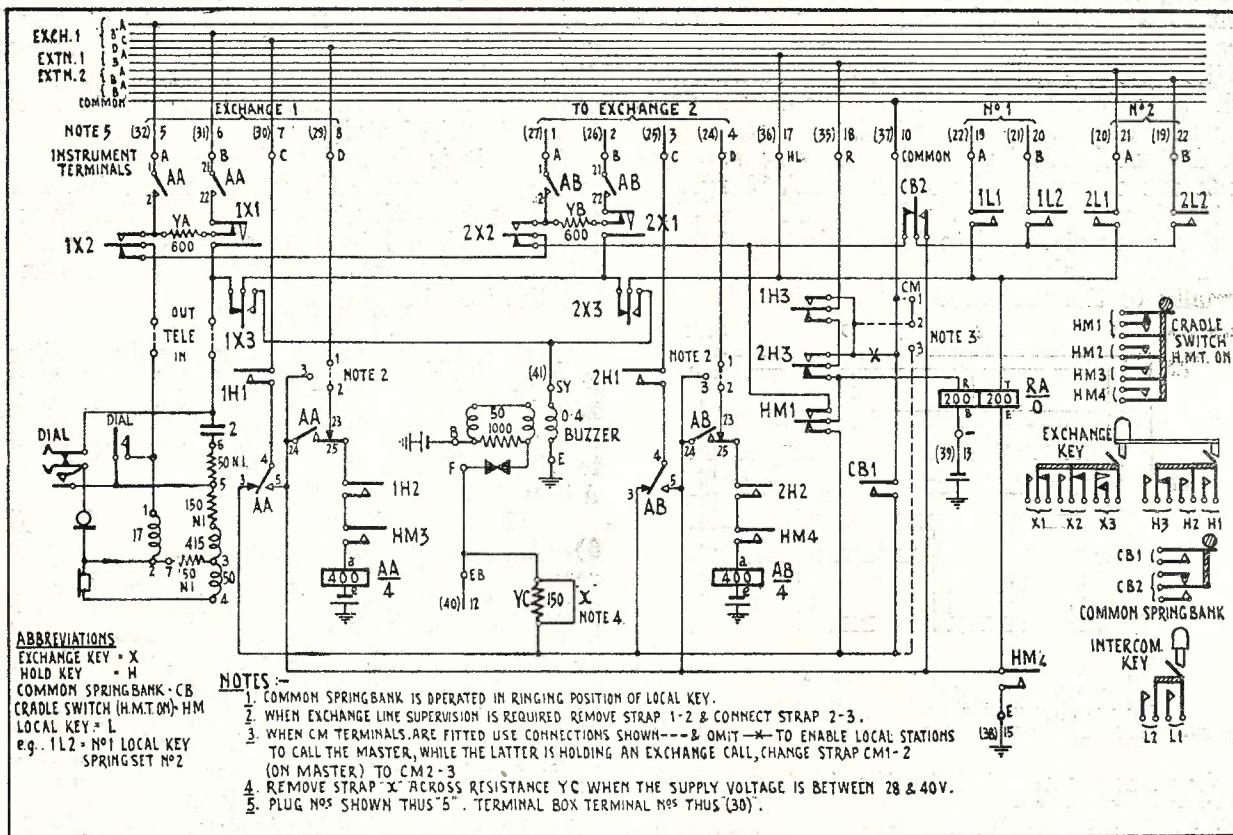

Fig. 6.—Telephone, Intercom. No. 2 Schematic Circuit.

is able to break in on a connection between two other extensions.

If the called extension is engaged on an exchange call the hold (H) springs on the appropriate exchange line key will be operated, and at 1H3 or 2H3 the R wire will be connected to the common. When the caller fully depresses the appropriate local key, the earth placed on the R wire of the called extension is extended to the common. This earth is returned to the calling extension on the common wire and operates the caller's buzzer via CB1. This serves as an engaged signal indicating that the caller is engaged on an exchange call.

At the termination of a call both extensions replace their handsets, which action mechanically restores all operated keys to normal.

at BZ24-25 and releases after its slow release period, whereupon it immediately commences to re-operate. Relay BZ thus alternately operates and releases during the time the local key at the calling extension is fully depressed. The contacts of relay BZ make and break at a frequency of approximately 16-20 per second and the resultant reversals of potential sent to line via BZ1.2.3 and 21.22.23, ring the magneto bell at the external extension. During the ringing period, the 0.5 M.F. condensers act as a spark quench across the BZ contacts. Relay L does not operate when ringing current is being sent out to line. When earth is removed from the R wire, relay H holds from earth via KX3, coil of relay H, HL wire, calling extension telephone loop, R wire, KX4, coil of relay H to battery. Relay BZ releases as

it will not hold in parallel with relay H under this condition.

When the external extension answers, relay L operates over the loop and L1.2 and 3.4.5 extend the A and B wires to the calling extension. L2.2.23 serve no purpose at this stage.

If the external extension is engaged on a call with another extension, relays H and L will be operated, therefore when the caller fully depresses the local key, relay BZ will not operate, as the circuit is open at L3.4. When the local key restores to the "speaking" position the caller breaks into the local connection.

If the external extension is engaged on an exchange call, key springs KX4 will be operated, thereby connecting the R wire to the common. Therefore, when a caller fully depresses the local key, his own buzzer will operate. At the termination of a call; both extensions replace their handsets. Relays L and H release and the circuits are restored to normal.

External Extension Calling Internal Extension (Figs. 6 and 8).—The external extension must first call the main station by lifting the handset. Relays L and Q operate via earth, YA, BZ1.2,

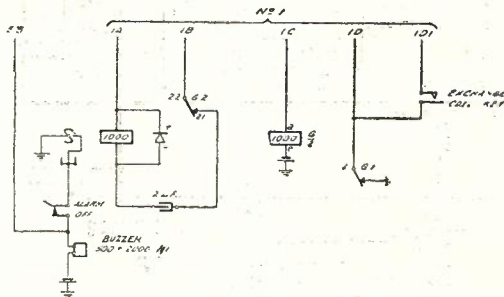

Fig. 7.—Unit, Transfer No. 1B and 2A Schematic Circuit.

L150, KX1, external extension loop, Q50, KX2, L150, BZ21.22, YB50, to battery. Q1.2 operate relay QR, which has no function at this stage. Relay L prepares to extend the external extension line to the HL and R wires and at L2.2.23 connects earth to operate the extension indicator which in turn operates the buzzer.

The main station answers by depressing the local key corresponding to the external extension, thereby connecting his telephone to the external extension line via the HL and R wires in the transfer unit as explained for an internal extension, i.e., by the operation of relay H which also short circuits relay Q and opens the indicator circuit.

The external extension informs the main station of the number of the internal extension required. The main station then calls the particular internal extension, the operation being similar to that described previously. The called extension, upon answering, is asked to call the external extension. The main station restores the handset and the call proceeds as for an internal to an external extension call.

Internal Extension with Full Facilities Calling the Exchange (Figs. 6 and 7 or 8).—To call the public exchange, an internal extension lifts the handset, thereby operating the HM contacts, and depresses (say) exchange key No. 1, thus operating the X and H springs. 1X1 and 1X2 remove the hold coil and prepare to connect the telephone to the exchange line. These springsets also disconnect the local side of the circuit. 1H1 prepares an engaged test circuit. 1H2 prepares an operate circuit for relay AA. 1H3 connects the R and the common wires to provide an engaged test to calling extensions.

If the exchange line is free, relay AA operates from battery, coil of AA, HM3, 1H2, AA23.25, D wire to earth at G1.2. Relay AA operates and locks to earth at HM2. AA1.2 and 21.22 extend the telephone circuit to the A and B wires and thence to the exchange line. AA4.5 extend earth via HM2 and 1H1 to the C wire to operate relay G in the transfer unit. Relay G, in operating, removes earth from the D wire to avoid intrusion by other extensions. G21.22 remove the exchange indicator from the line. The caller now receives dialling tone and dials the number required.

At the termination of a call the calling extension replaces the handset, thereby restoring the HM, X and H spring banks. Relays AA and G release to restore the circuits to normal, and clear the exchange line.

When the key of an engaged exchange line is depressed (with the handset on or off the rest) the caller's buzzer will operate from battery, coil of buzzer, AA3.4, 1H1, C wire to an earth applied by the HM2 contacts of the engaging extension. The caller's AA relay will not operate due to absence of earth on the D wire of an engaged exchange line and secrecy is thus provided.

External Extension Calling Exchange — Day Service (Fig. 8).—To gain access to the public exchange, the external extension must first call the main station. The main station having ascertained that an exchange call is required, tests the exchange line by depressing the exchange line key on his telephone. If a line is free, it is switched to the external extension through the appropriate "Extension to Exchange" key on the transfer unit. The main station then replaces the handset. The "Extension to Exchange" (KX) key springs function as follows:—KX1 and KX2 connect the external extension to the A and B wires of the exchange line. KX3 extends an earth via KX5 to the C wire to operate relay G to clear the exchange line indicator and place the engaged test condition on the exchange line. KX4 disconnects relay BZ from the R wire which is connected to the common to busy the extension against incoming local calls. KX6 has no function at this stage. Relay Q operates from public exchange battery via the extension loop and at Q1.2 operates relay QR. QR1.2 disconnect the

extension indicator. On dialling, relay Q responds to the dialling impulses, but QR being slow to release, remains operated. On completion of a call, the extension replaces the handset to give a through clear to the exchange. Relay Q releases followed by relay QR, which operates the extension indicator from earth at KX3 via QR1.2. The main station restores the "Extension to Exchange" key to normal.

Incoming Exchange Calls (Figs. 7 or 8).—All incoming calls are received on the transfer unit at the main station. The eyeball indicator operates to rectified ringing current from the ex-

tension via the appropriate L1 springs, 2X3, 1X3, telephone loop, 1X2, 2X2, CB2 and the appropriate L2 springs. The called extension answers and is requested to take over the exchange call. To do this, the extension depresses the appropriate exchange line key, whereupon his buzzer will operate. Buzzer tone is passed back to the main station from earth, 0.4 ohm coil of buzzer, 1X3 or 2X3, HL wire, thence to the main station via the appropriate L1 springs, to the telephone circuit. On receipt of tone, the main station replaces the handset; this restores all keys to normal and removes the busy condition from the C

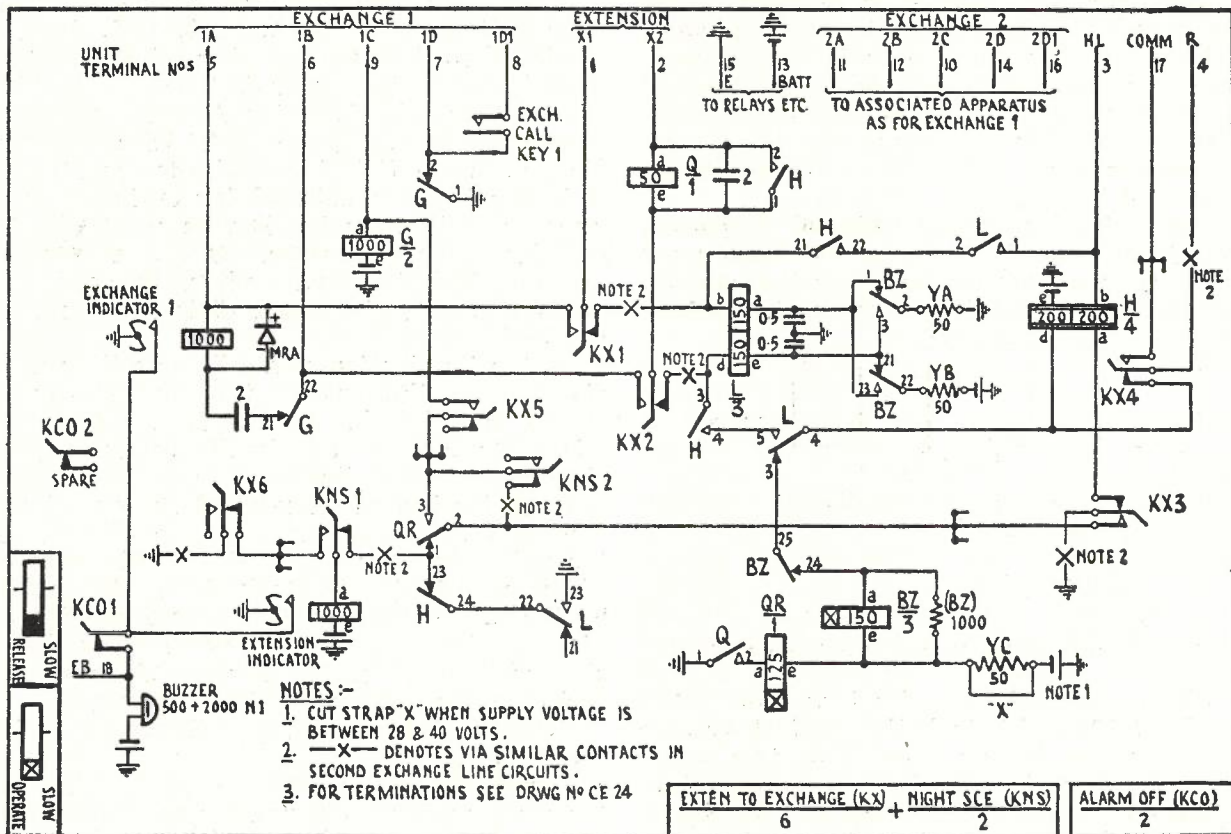

Fig. 8.—Unit Transfer No. 1A and 3A Schematic Circuit.

change. The main station answers by lifting the handset and depressing the appropriate exchange line key on the telephone. The circuit operation is then as described previously.

Call for an Internal Extension (Fig. 6).—When the number of the extension required is ascertained, the main station fully depresses the corresponding local key. This operation mechanically restores the exchange line key to the "hold" position. In this position the H springs remain operated, but the X springs are released and the exchange line is held by the 600 ohm hold coil YA or YB. The main station telephone set is disconnected from the exchange line at springs 1X1 and 1X2 and when pressure is released from the local key the telephone is switched to the A and B lines of the called ex-

and D wires. The AA or AB relay at the extension then operates to earth on the D wire and so connects the extension to the calling exchange line. If the required extension is engaged on a local call, the main station breaks in on the connection and offers the exchange call. If the required extension is engaged on an exchange call, the main station can break in on the connection only if provided with monitoring facilities.

If the person required is not at the extension called and as a result of a search, he calls the main from another telephone, provided the CM terminals 2-3 are strapped, the main station buzzer operates. The exchange call is then transferred, by the local caller depressing the relative exchange key and the main clearing as described. If the CM terminals are strapped 1-2 the main

cannot be called whilst holding an exchange call unless monitoring facilities were provided on extensions and if this were done exchange calls would not be secret.

Upon ascertaining that the external extension is required, the main station calls the external extension by depressing the appropriate local key, the exchange line being held as described. When the external extension answers, the main station then throws the appropriate "Extension to Exchange" key on the transfer unit and replaces the handset. The call proceeds as described previously.

Transference and Holding of Exchange Calls (Figs. 6 and 8).—Internal Extension to Internal Extension.—If an extension, after speaking on an exchange line, desires to transfer the exchange call to the main station or to another extension having full facilities, the operations are similar to those described for a main station transference.

Internal Extension to External Extension.—An exchange call cannot be transferred direct from an internal extension to the external extension, but must be transferred via the main station.

External Extension to Internal Extension.—By "flashing" the main station exchange calls can be transferred from the external extension to any other extension via the main station. In automatic areas, calls originated by the external extension cannot be transferred.

Holding one exchange line while transferring a call on the other.—If on an installation with two exchange lines, the main station is talking on one line and a call is received on the second line, the main station may temporarily abandon the call on the first line and by depressing the second exchange line key (which automatically restores the first exchange key to the "hold" position) may accept the call. The main station then depresses the local key corresponding to the number of the extension to which it is desired to transfer the call. This causes the second exchange line key to restore to the "hold" position. If the call is for the external extension, the transfer is completed by operating the "Extension to Exchange" key on the transfer unit. If the transfer is to an internal extension, the procedure is as described earlier except that on receipt of the buzzer tone the main station releases the second exchange line by operating the

associated "trigger" key. This causes the "hold" springs associated with the second line to restore, while leaving the "hold" springs on the first exchange key in the operated position. The first exchange key has meanwhile remained in the "hold" position and by again fully depressing this key the main station may continue the conversation on this exchange line. The action of fully depressing the exchange key also restores the local key previously operated.

An internal extension with full facilities may, in the same manner, hold one exchange line while transferring a call on the second exchange line.

Holding one exchange line while making a call on the other.—The depression of the second exchange key automatically restores the first exchange key to the "hold" position. The call is then set up as described previously. Either exchange call may be transferred. On the termination of the call on the second exchange line, connection with the first exchange line may then be re-established by again fully depressing the first exchange key. The operation of the associated "trigger" key releases the second line.

Miscellaneous Facilities.—The three principal facilities are:—

External Extension—Night Service.—The external extension is switched to an exchange line by the operation of two keys on the main unit. When the exchange line concerned is free, it may be used by internal extensions, but under these conditions calls are non-secret to the external extension.

Restricted Access. — Any internal extension wired to prevent exchange access can be connected at the discretion of the main station, who selects a free line, tells the extension, and presses the "exchange call" button on the transfer unit. This button completes a circuit for the AA relay of the calling extension to earth at the normal contact G1.

Conference Calls.—They are made by first calling the required extensions individually. The conference key is then depressed and a locking bar enables any number of local keys to be depressed and held in the operated position.

Acknowledgment.—The telephones ordered under Schedules C.2271 and C.2424 are being supplied by Messrs. Ericsson Telephones Ltd., and much of the information embodied in this article has been kindly made available by them.

AN AUDIBLE CODE CALL SYSTEM

L. T. Batty and S. Mulhall

Introduction.—A code call system provides a facility whereby an executive officer of a business organisation may be located expeditiously in any part of the premises. It is required chiefly as an adjunct to the telephone service. In general, it is of advantage to base the design of a code call system on the use of uniselectors and telephone type relays, because they are stock items and in association with a P.A.B.X. as suitable power supply is available.

Code signals are made by means of lamps (particularly in buildings in which limitation of noise is essential) or bells, buzzers or hooters. Code calls are generally set up by the manual switchboard telephonist, but, if necessary, on large P.A.B.X. installations they can also be set up by any extension. A separate code is allocated to each executive, who, when he sees or hears his particular signal, goes to the nearest telephone and calls the code answering number. On some P.A.B.X.'s on which the code set up and answering equipment is wired from the automatic switches, this automatically restores the code set up equipment to normal and connects the wanted executive to the caller. On other services the code set up equipment is a separate unit, and the wanted executive calls the manual switchboard. The telephonist clears the code call system and connects the caller. This arrangement would apply if the system is associated with a P.B.X., and it is particularly suited for systems associated with unit type ("C" or "C.A.") P.A.B.X.'s, in that as the number of connecting circuits is limited and cannot be increased readily, it is unwise to reduce the traffic handling capacity by using these circuits for code call purposes. This article describes a system of this type, but the fundamentals are generally similar to a complete automatic system.

In Vol. 2, page 372, a large lamp signalling system installed at the Brisbane General Hospital is described. Variations of this method, such as the lighting of four or five lamps separately or in various combinations and the use of ten's and unit lamps, have been installed for other subscribers. In many factories it is essential to employ a system which will attract attention above the noise of machinery, therefore bells or loud-sounding alarms are used.

It is the purpose of this article to describe the installation at the mill of the Australian Paper Manufacturer's Ltd., Maryvale, Victoria. As the mill consists of 28 buildings in an area of 25 acres, the time taken to locate an executive officer may be appreciable if a code call system was not provided. Besides inconvenience to the subscriber, the extra time incurred in completing trunk line calls, which comprise a large propor-

tion of the traffic over exchange lines, would result in a reduction in the efficiency of the trunk line service.

Code Call Equipment.—The subscriber required equipment for 20 codes to be provided in conjunction with a type "C.A." P.A.B.X. The following equipment was installed in the unit to provide the code call system:—

Code Selector:—A 4 level, 25 outlet unselector which is controlled by a dial and used to select any one of 20 codes.

CODE	DIGITS DIALLED	CODE SIGNAL	CODE	DIGITS DIALLED	CODE SIGNAL	CODE	DIGITS DIALLED	CODE SIGNAL
1	2	--	8	5	-----	15	07	-----
2	3	---	9	01	-----	16	08	-----
3	4	----	10	02	-----	17	09	-----
4	5	-----	11	03	-----	18	001	-----
5	6	-----	12	04	-----	19	002	-----
6	7	-----	13	05	-----	20	003	-----
7	8	-----	14	06	-----			

Fig. 1.—Code Signals.

Code Distributor:—A 5 level, 25 outlet unselector operated at 5 steps per second by means of interrupted ground pulses which are available from the P.A.B.X.

Relay Groups:—Three relays are used to control the uniselectors, one relay is used to assist in arranging the code groups and one relay to distribute the code signals.

Code Groups.—The code groups are combinations of short and long impulses. The digits dialled and the resultant code signals are shown in Fig. 1. The short and long impulses are obtained by connecting the bank contacts of the code distributor switch as shown in Fig. 2.

Operation.—The dial on the P.A.B.X. manual switchboard is used to set the code call equipment to the code desired. Both uniselectors are wired to "home" when a set-up is released, to ensure that when the equipment is used again the switches will step from zero—otherwise incorrect codes would be set up. It is of interest to consider the set-up of both single and two or three figure codes—e.g., code 3 (dial 4) and 12 (dial 04). To set up code 3, the non-locking key is depressed and 4 is dialled, operating impulsing relay A.

1-2-3 complete the circuit of relay B, which holds during the impulsing.

21-22-23 connect ground to the wipers of the C.D. unselector.

24-25 prepare a hold circuit for A.

Relay B operating—

1-2-3 complete a circuit for C.S. unselector magnet to step the switch contact 4.

4-5 complete a circuit for relay C, which holds during impulsing.

6-7 prepare a circuit to connect interrupted ground to the D.M. of the C.D. unselector.

21-22-23 switch ground from wiper C.D.5 to wiper C.S.5.

24-25 complete ringing machine start circuit (to supply ground pulses).

Relay C operating—

1-2 prevent operation of C.D. magnet, until the first impulse train is completed.

21-22 prevent completion of locking circuit for relay A until the first impulse train is completed.

On the completion of dialling, relay C releases, completing a locking circuit for relay A, and the C.D. switch steps from interrupter ground via C. 1-2. The code set up key is then released. The C.D. switch operates at a speed of 5 steps

C.D. switch. Relay B opens the circuit of C at B.4-5, and B.1-2-3 and 21-22-23 complete the homing circuits for the C.S. and C.D. uniselector magnets, which, by self-interruption, step the uniselectors to the home contacts and the equipment is clear for the next call.

To set up code 12, the non-locking key is depressed and 0 is dialled, operating relays A, B and C as described above. The C.S. switch steps to contact 10. On this contact (and also on 20) relay C remains operated from ground via B.22-23 and the C.S.2 wiper. When 4 is dialled, the switch steps from contact 10 to 14 and relay D operates from ground via B.22-23 and the C.S.2 wiper. At the end of the second impulse train,

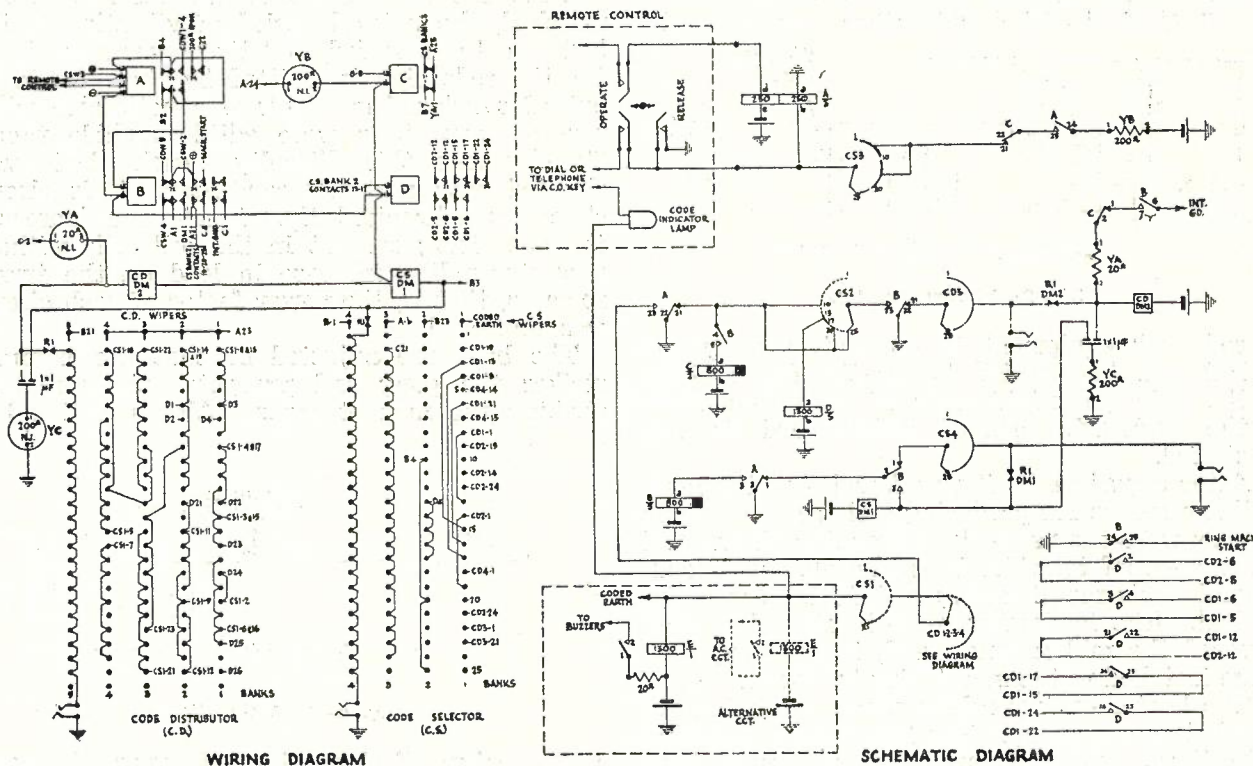

Fig. 2.—Code Call Equipment Circuit.

per second and referring to Fig. 1, code 3 is one long and one short signal. Referring to Fig. 2, a long signal is equal to 3 steps of the C.D. switch and a short signal to 1 step. The code signal is repeated every 5 seconds. The coded ground from the C.D. switch is applied to relay E, which repeats the code to the signalling equipment. The telephonist can check the code sent out by observing the code indicator lamp. When the called party answers by dialling the manual switchboard from the nearest telephone, the telephonist depresses the non-locking key, which applies ground to short circuit the holding winding of relay A, which releases and opens the circuit of relay B. After the release of A and during the slow release of B, relay C is reoperated to open the stepping circuit of the

relay C releases, etc., as described above. The release of the set-up relays and of the code call equipment after the called party has replied is also as described above.

It should be noted that relay D is introduced to combine some of the one and two digit codes to make three and four digit codes and operates whenever codes 03, 04, 05, 06 and 07 are set-up. The first contact of the C.S. switch is not used because of the danger of a false impulse, which would result in the sending of an incorrect code signal.

Audible Signals.—In providing audible signals at the Paper Mills the following factors had to be considered:—

1. The tone of the signals had to be readily

distinguishable from signals which were in use for fire and ambulance purposes.

2. In many locations, the room noise due to wood-chopping machines, etc., was extremely bad.

3. Limitation of cable pairs in the underground cable in situ.

4. Power supply—a high current drain from the P.A.B.X. battery could not be provided and the voltage drop over long cable leads had to be considered, as well as the current rating of the wires.

5. Trouble-free Service.—Reliable operation is essential both from the viewpoint of the subscriber and the maintenance mechanic who has a large country district to maintain.

6. Control.—The subscriber required the

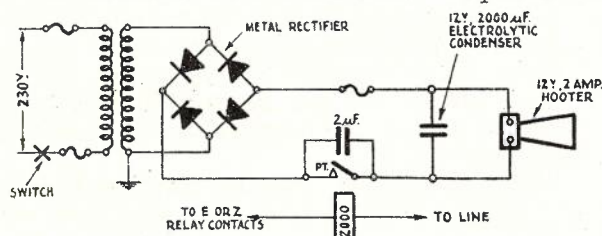

Fig. 3.—Hooter Circuits.

code call equipment to be controlled by the P.A.B.X. telephonist during the day and by the principal night-switched extension when the P.A.B.X. manual switchboard is not staffed.

After experiments, it was found that the most suitable means for producing satisfactory audible signals were the use of loud-sounding alarms and weather-proof trembler bells. In all, seven loud-sounding alarms (hooters) and 16 bells were installed. The hooters were so located that they covered the mill grounds, and, in addition, they were installed in the more noisy buildings.

The hooter control relays were connected in parallel as one group. The bells were subdivided into three groups, there being not more than seven bells per group. Each group was supplied with power from the commercial supply mains (230 volt, 50 cycle A.C.) through step-down transformers with an output rating of 75 V. 1.5 A.

The loud-sounding alarms are standard units to Drawing C.1023. For each unit the 230 volt commercial power supply is stepped down via a transformer and rectified by means of a metal rectifier in order to operate 12 volt motor horns. Fig. 3 shows the schematic circuit. The 200 mF 12 V. electrolytic condenser connected across the motor horn terminals improved the output note.

The weather-proof bells (standard 6" trembler type) in each group are connected in parallel. The normal interrupter contacts of the bells are short-circuited. As the bell armatures are fairly

heavy, they would not respond satisfactorily to 50 cycle A.C. Therefore a 3 amp. metal rectifier has been wired in one side of the power feed to each group to suppress one-half cycle of the A.C. The resultant pulsating D.C. gave a positive operate and release action to the armature at 50 strokes per second, whereas the 50 cycle A.C. required 100 strokes per second with almost negligible zero voltage intervals for the release of the armature. The use of rectifiers to improve the bell operation on A.C. has proved very successful. The results obtained by using trembler bells are far superior to those obtained with the standard magneto bell. The schematic circuit is shown in Fig. 4.

Since the impedances of the bells were not matched, the natural period of vibration of the bell armatures varied, and there was a tendency for the code signals emitted by the bells to be out of synchronism. This was noticeable when two or more bells were within audible range. To overcome this difficulty, each bell was shunted with a 2 mF condenser. This circuit change synchronised the signals and increased the energising current in the bell coils without a corresponding increase in load on the transformers, that is, the power factor of each circuit was improved.

The bells are adjusted so that the hammer strikes the gong and prevents the armature striking the magnet cores. Although this has

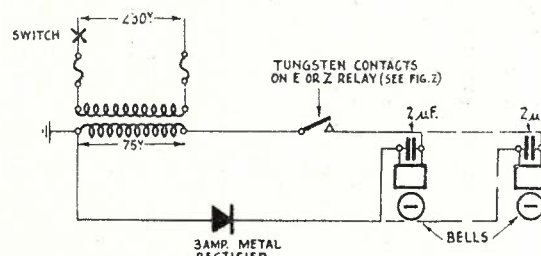

Fig. 4.—Bell Circuits.

a dampening effect on the bell gongs, the noise level created by the bells is still sufficient, even in noisy situations. Moreover, this adjustment assists the release of the armature during zero voltage intervals, and over a period of several months since the installation has been completed no maintenance has been necessary.

The current drain in the hooter relay group is 1 ampere and is less than 1 ampere in the largest group of bells. The secondary windings of all transformers are grounded as a safety precaution to guard against a breakdown between the primary and secondary windings. Each circuit is protected by standard 1.5 A fuses on the D.C. side.

The bells and hooters were divided into groups to reduce the current flow in any one cable pair to a minimum consistent with economy in cable pairs. The cable layout also lent itself to the

grouping arrangement. This, coupled with the individual power feed to each group, eliminated the possibility that a fault in one section would dislocate the whole system.

The coding of each group is controlled by a pair of heavy tungsten contacts per group on the E and Z relays referred to earlier. These

relays are in parallel and each is fitted with two pairs of contacts. The strategic placing of the hooters and bells is so successful that the code signals are heard and readily recognised, not only throughout the Mill buildings, but also over the surrounding paddocks up to a distance of half a mile.

STANDARD TEST SETS

W. King

Standard test sets have been designed to cover the necessary tests for most items and types of automatic exchange equipment. It is intended in this article to describe Test Sets Numbers 1 and 17, both these sets being combined test sets for testing the functions of the following switches:

- (a) Group Selectors.
- (b) Final Selectors and Final Selector Repeaters.
- (c) Repeaters.
- (d) Selector Repeaters.
- (e) Switching Selector Repeaters.
- (f) Discriminating Selector Repeaters.

Test Set No. 1

This test set is suitable for use in small automatic exchanges and for P.A.B.X.'s of the pre-2000 type. It consists of a test box mounted on a portable iron stand which may be wheeled to any bay or rack and connected to the switches by means of test cords and plugs.

The schematic circuit is shown in Fig. 1. The functions of the various components which are included in the set are described in the following paragraphs.

Certain components, such as the Test Number Plug, Bell, Tone Induction Coil, etc., are used

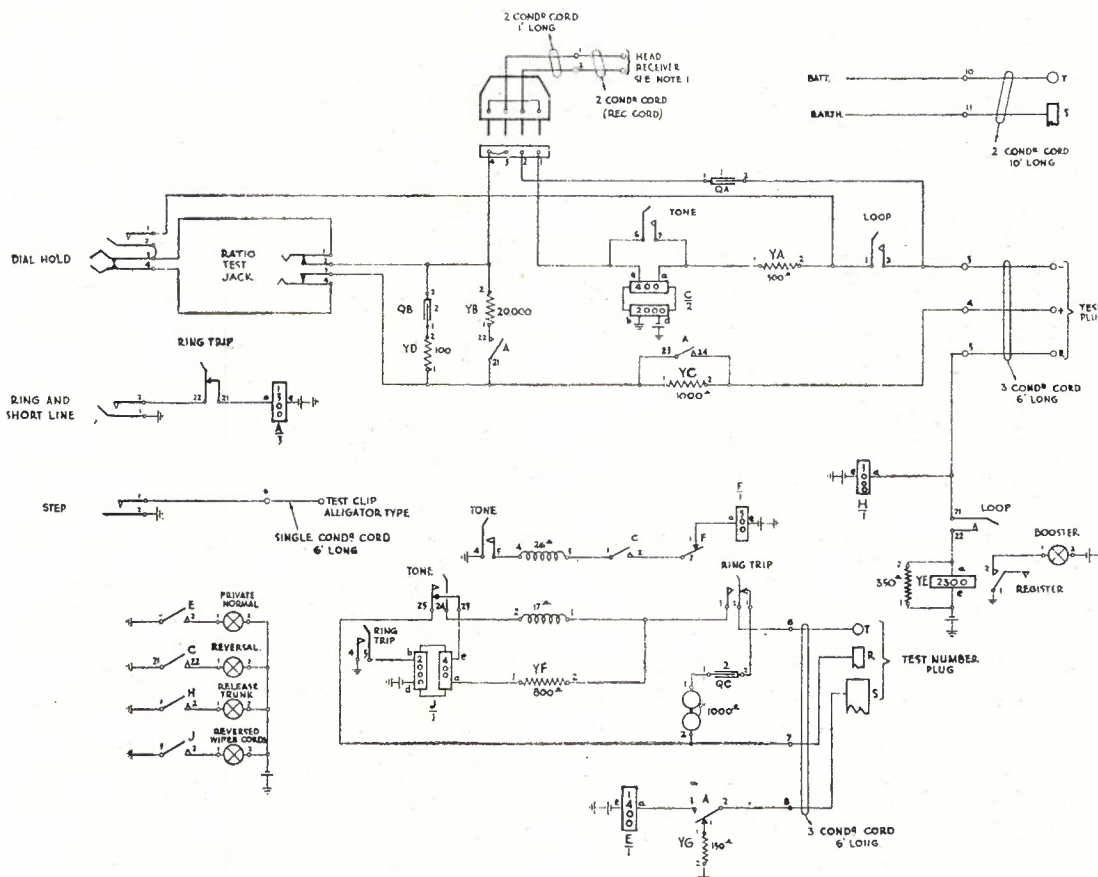

Fig. 1.—Test Set No. 1—Schematic Circuit.

Test Set No. 1 is suitable for pre-2000 Type Equipment and Test Set No. 17 for 2000 Type Equipment.

only when testing Final Selectors.

Final Selectors.—To test final selectors the test set functions as follows:—

(i) The test plug is inserted into the test jack of the switch under test, the test number plug into the test number jack and the battery plug into a convenient battery jack. Earth via YG (150 ohms) and A.1-2 is connected to the private of the test number.

(ii) Operation of A and B Relays in the Final Selector and Earth on the Release Trunk.

—Operate the Loop Key. A loop is connected to the final selector via YA (500 ohms), Relay C (400 ohm winding), Transmitter if connected, Dial and Res. YC (1000 ohms). Relays A and B in the final selector should operate and return earth on the release trunk. This causes the operation of Relay H in the test box and H1-2 complete the circuit of the Release Trunk Lamp which will light.

(iii) Impulsing Test, Long Line Conditions, Busy Test.—Dial the test number (99). The switch under test should step to this number under long line dialling conditions (1000 ohm loop), the remaining loop resistance being short circuited by the off normal springs of the dial. As busy conditions were imposed on the test number via the sleeve of the test number plug, Busy Tone should be heard in the test receiver.

(iv) Release of Final Selector.—Restore the Loop Key to normal. The switch under test should release and the Release Trunk Lamp in the test box ceases to glow.

(v) Impulsing Test, Short Line Conditions, Ring Test.—Operate the Loop and Ring and Short Line Keys. Relay A in the test box operates via the Ring and Short Line Key.

A23-24 short circuit Res. YC (1000 ohms).

A21-22 connect a 20,000 ohm shunt across the dialling loop.

A2-3 connect relay E to the private of the test number. (This is equivalent to a B.C.O. relay in a first uniselector circuit, but slightly higher resistance.)

Relay H will again operate with earth on the release trunk and the Release Trunk Lamp will light. Dial the test number (99). The switch under test should step to the test number under short line dialling conditions (20,000 ohm shunt), and the bell in the test box should ring. Relay E in the test box will operate and complete the circuit of the Private Normal Lamp, which lights. During the ringing periods ringing tone should be heard in the test receiver.

(vi) Ring Trip and Reversal, Wiper Cords Reversed.—Operate the Ring Trip Key during a silent period. A 1200 ohm resistance is now connected across the positive and negative normals of the test number and the ring should trip. In Booster Type exchanges the operation of the register should take place and the Booster Lamp in the test box should light. The ring trip and the reversing relays in the

final selector should now be operated and a reversal of battery should take place. Relay C, which is polarised, should now operate and complete the circuit of the Reversal Lamp, which should light. C1-2 prepare the tone circuit. Shake the wiper cords on the switch under test to detect any intermittent opens in the cords, which will be indicated by clicks in the test receiver. If the wiper cords on the switch under test are reversed relay J in the test box, which is polarised, will operate and J1-2 will complete the circuit of the Reversed Wiper Cords Lamp, which will light.

(vii) Transmission.—Operate the Tone Key, Relay F in the test box will vibrate, and a tone should be heard clearly in the test receiver. Contacts of the Tone Key also short circuit relay C to prevent inductive effects from relay F.

(viii) Momentary Open on Release Trunk.—When testing Last Party Release Type Final Selectors, with the Ring, Ring Trip and Loop Keys operated test for a momentary open on the release trunk by restoring the Loop Key. A "Blink" should be observed on the Release Trunk Lamp. Repeat this test by operating and restoring the Loop Key several times. The lamp should blink each time the key is restored. (This open is necessary to allow the train of switches preceding the final selector to restore and be available for further calls.) The final selector is then held busy until the called party restores his receiver; this is indicated by the steady glowing of the Release Trunk Lamp after the blink. On Calling Party Release Type Finals the Switch will release when the Loop Key is restored.

(ix) Release.—Restore All Keys to normal; the switch should release and all lamps cease to glow.

Final Selectors, P.B.X. Type.—To enable the rotary step-on feature of P.B.X. final selectors to be tested, the 90 line should be connected to the Test Number Jack and the 99 line busied. When 99 is dialled on the test set, the switch should rotate to 90.

To test final selectors with circuits arranged for night switching on any but the first line of a group of P.B.X. lines the 90 line should be connected to the Test Number Jack and the 98 and 99 lines busied. The test number 98 should be dialled for the usual busy and ring tests and the switch should rotate to 90, but in order to test the night switching facilities 99 should also be dialled. The switch in this case should not rotate beyond the 99 contacts and a busy tone should be heard in the test receiver.

The tests to be performed on P.B.X. final selectors with these exceptions are similar to those detailed for Regular Final Selectors.

Final Selector Repeaters, P.A.B.X.'s.—The operation of Test Set No. 1, when used to test

final selector repeaters, is similar to that previously described for final selectors; an additional test is necessary, however, in order to test the repeating functions of the switch. The test is as follows:—

(i) Dial 0. The switch should step to the 0 level, cut in and rotate to the first free exchange line.

(ii) Dial the test number (08) and observe that the Reversal Lamp glows and that tone is heard clearly in the test receiver.

When testing junctions from Final Selector Repeaters, it will be necessary to step the switch to each contact on the 0 level to which an exchange line is connected and repeat test (ii) indicated above.

Group Selectors.—To test group selectors the test set functions as follows:—

(i) Connect the Test Plug to the test jack of the switch under test. Connect the Battery Plug to battery.

(ii) **Operation of A and B Relays in Selector and Earth on Release Trunk.**—Operate the Loop Key. A loop is connected to the selector and relays A and B should operate and return earth on the release trunk. Relay H in the test box operates and completes the circuit of the Release Trunk Lamp, which lights.

(iii) **Impulsing Test, Long or Short Line Conditions.**—Dial the desired level. The switch should step to the level under long line dialling conditions and cut in. For short line dialling conditions, operate the Short Line Key before dialling.

(iv) **Switching; Reversed Wiper Cords.**—Dial one and observe that the switch does not release and that there is no chattering of the relays. If the wiper cords or the trunk are reversed, the polarised relay C in the test box will operate and the Reversal Lamp will light.

(v) **Release.**—Restore the Loop Key to normal. The selector should release and the Release Trunk Lamp should cease glowing.

Repeaters.—To test Repeaters the test set functions as follows:—

Automatic to Automatic Repeaters.

(i) Connect the Battery Plug to battery.

(ii) **Test for Busy Repeater.**—With all keys normal insert the Test Plug into the test jack of the repeater under test. If the Release Trunk Lamp glows, listen in the test receiver to ascertain whether the junction is busy.

(iii) **Operation of A and B Relays and Earth on Release Trunk.**—Operate the Loop Key; the Release Trunk Lamp should glow. If the Reversal Lamp lights at this stage a reversal of the junction is indicated.

(iv) **Repeating Test.**—Dial the test number (08) of the exchange in which the junction terminates. The test circuit is arranged to give a reversal of battery followed by tone over the junction. The Reversal Lamp in the

test box should light and a tone should be heard in the test receiver. When dialling under long line conditions, the Short Line Key should be operated on the completion of dialling to ensure that the reversing relay in the test box operates. In booster exchanges the Register Lamp in the test box should also light.

(v) **Release.**—Restore the Loop Key. The A and B relays in the repeater should restore and the Release Trunk Lamp in the test box should cease to glow.

Automatic to Manual Repeaters.—The operation of the test set when used to test this type of repeater is similar to that described for automatic to automatic repeaters with the following exceptions:—

(i) The operation of the Loop Key completes a loop to the distance exchange. When a calling signal is observed on a junction the testing officer at the manual exchange should plug in and speak. He should then connect the junction to a junction test circuit by means of a test cord and plugs. The test circuit is arranged to give a reversal of battery and tone over the junction. The testing officer at the automatic exchange should observe that the Reversal Lamp in the test box lights and that the tone is heard clearly in the test receiver. The Loop Key should then be restored to normal. A momentary open on the release trunk should take place due to the junction being held in the manual exchange. This will be indicated by a blink on the Release Trunk Lamp in the test box. Observe that the repeater is guarded after the momentary open by observing that the Release Trunk Lamp remains glowing after the Loop Key has been restored.

(ii) The test set is then connected to the next repeater and the Loop and Short Line Keys operated. When the testing officer at the manual exchange receives a call on the second junction the first junction should be released, and the second junction connected to the test circuit. In small manual exchanges where no junction test circuits are provided, the testing officer should speak on each junction. Each junction should then be plugged through to a telephone in the switch room and the ringing key operated.

Selector Repeaters.—The functioning of the test set when used to test selector repeaters is similar to that previously described for selectors and repeaters. When testing junctions, however, from Selector Repeaters by means of the test set, when the switch cuts in on a level, dial the test number of the appropriate exchange and observe that the Reversal Lamp glows and that the tone is heard clearly in the test receiver. Step the switch to the next contact and repeat the test on that junction. Continue testing in this manner until all junctions from the level

have been tested. Release the switch, dial the next level and repeat the above test until the junctions from all working levels have been tested.

Switching Selector Repeaters. — When testing these switches with the test set, the impulsing, reversing and other functions of the switch are tested in a similar manner to that described for selectors and repeaters. When testing junctions from switching selector repeaters by means of the test set it is necessary to perform the tests from the junction uniselectors, where the testing officer can control the operation of the uniselector associated with the switching selector repeater under test. In exchanges where the junction uniselectors and switching selector repeaters

under test to the test jack on the bay by means of the double-ended cord.

- (ii) Connect the Battery Plug to Battery.
- (iii) Connect the Test Plug of the test set to the test jack mounted on the uniselector bay.
- (iv) Connect the stepping lead to the interrupter spring of the uniselector from which the test is to be performed.
- (v) By means of the Stepping Key in the test box step the junction uniselector to the first contact.
- (vi) Operate the Loop Key in the test box. The Release Trunk Lamp should light.
- (vii) Dial the test number of the main exchange and observe that the Reversal Lamp

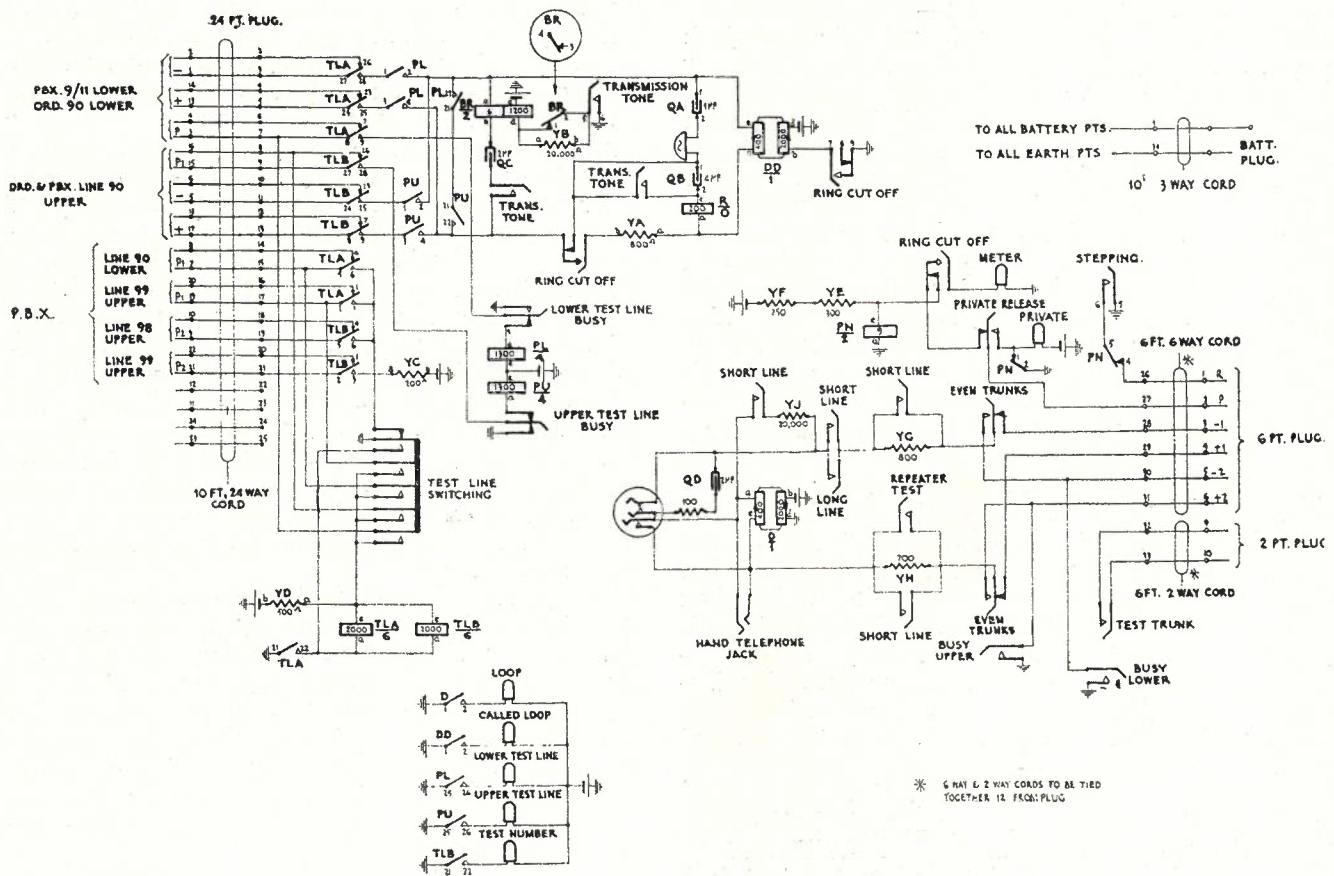

Fig. 2.—Test Set No. 17 Schematic Circuit.

are mounted on different bays, the test set should be connected to a three-way jack mounted on the junction uniselector bay. This jack should be connected by permanent wiring to a jack or jacks mounted on the switching selector repeater bays. From these jacks by means of a double-ended cord equipped with suitable plugs, a connection may be made to the test jack of each switching selector repeater. The operation of the test set in such cases is as follows:—

- (i) Connect the switching selector repeater

lights and that tone is heard clearly in the test receiver. In booster exchanges the Booster Lamp should also light. Should the Reversal Lamp light before the completion of dialling, a reversal of the wiper cords or junction is indicated.

- (viii) By means of the Stepping Key step the junction uniselector to the second contact and again dial the test number of the main exchange and observe the reversal and tone. Repeat the above tests on each of the 25 con-

tacts of the junction uniselector. When dialling under long line conditions, the Short Line Key should be operated on the completion of dialling to ensure that the reversing relay in the test set operates.

Test Set No. 17

This test set is suitable for use in small 2000 type exchanges where Automatic Routers are not provided and in some cases in larger exchanges equipped with routers, for individual tests on the various switches.

As the general functions of this test set are similar to those of Test Set No. 1 just described, only those features which differ and are of special interest will be described.

The schematic circuit is shown in Fig. 2. This test set provides for testing 100 line and 200 line final selectors, also 100 and 200 outlet group selectors, in addition to repeaters, etc.

Final Selectors.—In 2000 type exchanges the test numbers are connected to a 24 point test jack and are picked up by the test set by means of a 24 point test plug. It will be appreciated also that the final selector normals are connected through to their respective uniselectors normally via the test jack springs, and when the test plug is inserted via the normal contacts of the test line relays TLA and TLB in the test set. This arrangement allows the test numbers to be allotted for service.

Before any tests are made, the Test Line Switching Key in the test set is operated. Earth via the key is connected to one side of relays TLA and TLB, which will operate and lock if all test numbers are free. If, however, any test number is busy the relays are short circuited by earth on the busy line and cannot operate. This is indicated by the failure of the Test Number Lamp to light. In this case the Test Line Switching Key is immediately restored to normal. If the test numbers are free the operation of TLA and TLB relays switch the final selector normals through to the test set and the Test Number Lamp will light.

Provision is made also in the test set to busy the upper or lower test numbers, keys being provided for this purpose. Relays PU and PL

provide the switching battery potential for the Upper and Lower test lines respectively, and operate when the Final Selector under test switches. Privates in contact will cause both relays to operate and short circuit the negative and positive lines in the test set and trip the ringing.

A six-point and a two-point test plug are provided for connection to the switch test jacks of 200 line final selectors and 200 outlet group selectors. The two-way plug is connected to the Test Trunks Key, which is operated to check the bell or buzzer which indicates that the switch under test has switched on the set of wipers to the upper or second 100 lines. The six-point plug picks up the ingoing trunk to the final selector or other switch under test.

Selectors.—When testing 200 outlet group selectors by means of the test set, provision is made to busy the upper or lower private wiper so that switching on the HA or HB relays in the selector may be tested.

A special feature in the test set is the method of testing for busy and maintaining a busy condition on the switches under test. By reference to the circuit it will be seen that a low resistance relay PN is connected to the release trunk of the switch under test. PN will be normally operated via resistances YE and YF and the circuit of the Private Lamp is open at PN1-2. If the switch under test is busy, however, earth on the release trunk will short circuit PN, which will restore and the Private Lamp will glow, in which case testing should be transferred to the next switch. On non-busy switches earth via the low resistance winding of PN relay serves to busy the switch against intrusion during intervals between tests.

It will be observed that a Private Release Key is provided to remove the earth via relay PN during release. This is necessary when testing group or digit absorbing selectors. With this key operated the Private Lamp is connected to the release trunk, so that it may be observed that during release the earth on the release trunk is maintained until the wiper carriage has almost returned to normal. This checks the Guard on Release feature.

PAPER RATIONING

The Board of Editors regrets the delay in the publication of this issue of the "Journal" owing to negotiations in respect to paper rationing. To assist the war effort, this, and future issues of the "Journal," will be limited to 64 pages and will be printed on thinner paper than has been used for earlier issues.

AERIAL LINE CONSTRUCTION—PART 1

A. S. Bundle

Introduction.—For many years, all telephone wires were carried on poles, first as open wires attached to insulators and later in cables supported by steel cables suspended between poles. Still later, these cables were laid underground, first in wooden troughing and then in other forms of conduit such as earthenware, concrete or iron pipes.

Underground cables usually provide circuits which are more reliable and cheaper to maintain than open wires or aerial cables, but there are many circumstances in which open wire conductors are more satisfactory.

Some of the factors contributing to this are:

(a) The lower transmission value of cables due to the smaller separation of the conductors. To provide satisfactory transmission on long cable circuits it is necessary to take special precautions such as loading or installing repeaters.

(b) The higher cost of cables initially compared with open wire.

(c) The fact that it is necessary to provide all the circuits in a cable at once instead of adding wires as the demand requires.

Thus the aerial wire system of distribution is likely to persist for many years and these notes form the first of a series of articles on aerial line construction.

Poles

The essential requirement of a telephone pole is that it shall support the crossarms and other fittings which carry the telephone wires. That is, it must:—

(a) Be stable enough to act as a column fixed at one end.

(b) Have sufficient resistance to bending and rupture to withstand the horizontal stresses of the wind on the pole, fittings and wires. (Special measures are usually taken to counteract the force exerted by the tension of line wire.)

(c) Be purchased at a reasonable price and have a service life of approximately 15 years or more.

(d) Be easy to fit and erect.

(e) Be light in weight so as to keep transportation costs at a minimum.

Many forms of telephone poles have been de-

TABLE I.

Average life of pole timbers as assessed from record of poles, the lives of which were known, dismantled during 13-year period ended 30/6/40.

CLASS OF TIMBER		N.S.W.	Vic.	Qld.	S.A.	W.A.	Tas.	C'th. (not loaded)
Standard Reference Name	Standard Trade or Local Name							
<i>E. acmenioides</i> group	White Mahogany	22.1	—	—	—	—	—	22.1
<i>E. amygdalina</i>	Peppermint	—	—	—	—	—	13.7	13.7
<i>E. australiana</i>	Narrow-leaved Peppermint	19.4	—	—	21.	—	—	19.5
<i>E. cladocalyx</i>	Sugar Gum	—	10.3	—	13.6	—	—	13.4
<i>E. corymbosa</i>	Red Bloodwood	18.3	—	18.	—	—	—	18.24
<i>E. crebra</i>	Red Ironbark	—	—	—	—	—	—	—
<i>E. paniculata</i> group	Grey Ironbark	20.6	—	25.3	23.7	—	—	21.9
<i>E. siderophloia</i>	Red Ironbark	—	—	—	—	—	—	—
<i>E. eugenioides</i> group	White Stringy Bark	19.5	—	—	—	—	—	19.5
<i>E. globulus</i> group	Southern Blue Gum	—	—	—	14.8	—	12.3	12.5
<i>E. hemiphloia</i> group	Grey Box	20.9	18.5	—	—	—	—	19.7
<i>E. macrorrhyncha</i>	Red Stringy Bark	20.	14.5	—	—	—	—	17.9
<i>E. marginata</i>	Jarra	—	19.2	—	12.7	17.6	—	17.7
<i>E. melliodora</i>	Yellow Box	18.7	—	—	—	—	—	18.7
<i>E. microcorys</i>	Tallow-wood	20.2	—	—	—	—	—	20.2
<i>E. muelleriana</i>	Yellow Stringy Bark	21.9	—	—	—	—	—	21.9
<i>E. obliqua</i>	Messmate Stringy Bark	12.	12.1	—	15.13	—	12.2	12.4
<i>E. pilularis</i>	Blackbutt	16.	—	—	—	—	—	16.
<i>E. propinqua</i> group	Grey Gum	18.9	—	—	—	—	—	18.9
<i>E. rostrata</i>	River Red Gum	—	—	—	—	—	—	—
<i>E. tereticornis</i> group	Forest Red Gum	24.	19.2	—	14.9	—	—	19.5
<i>E. sideroxylon</i>	Red Ironbark	21.9	17.9	—	—	—	—	18.9
<i>E. sieberiana</i>	Silver Top Ash	—	—	—	—	—	16.	16.
<i>E. trachyphloia</i>	Brown Bloodwood	—	—	13.3	—	—	—	13.3
<i>Callitris glauca</i>	White Cypress Pine	22.5	13.7	27.6	18.5	—	—	22.9
<i>Phebalium squameum</i>	Tasmanian Tallow-wood	—	—	—	—	—	17.1	17.1
<i>Phyllocladus rhomboidalis</i>	Celery Top Pine	—	—	—	—	—	18.4	18.4
<i>Syncarpia laurifolia</i>	Turpentine	18.1	—	—	—	—	—	18.1

veloped and used. Those chiefly used in Australia are:—

- (a) Wooden poles.
- (b) Tubular steel poles of the Oppenheimer, Siemens or Stewart & Lloyds type.
- (c) Rail poles (i.e., poles constructed of railway or tramway rails which usually have been recovered after being used for their primary purpose).
- (d) Steel beams, i.e., H section girders.

Wood Poles.—The trunks of trees are required to withstand loads similar to those applied to telephone poles. Hence tree trunks are designed by nature to take the shape closely approaching the ideal for the telephone pole, and the majority of telephone poles are made from tree trunks, from which the bark has been removed. In Australia we have been fortunate in having available a range of hardwoods, principally of the Eucalyptus genus, which possess strength and durability. Unfortunately, our forests are rapidly being denuded and suitable trees for poles are now more difficult to obtain; hence from a national viewpoint it is desirable to—

- (a) Preserve existing poles as much as possible, and
- (b) By suitable preservative methods to increase the range of timbers that would prove suitable for use as poles.

Life of Wood Poles.—Table I. shows the average lives of pole timbers used in the Postmaster-General's Department. These figures have been assessed from records of some 230,600 poles of known life that have been dismantled during the 13 years ended 30.6.40.

The loaded average life of wood poles throughout the Commonwealth, taking account of the relative proportion of aerial construction in each State, is 18.62 years.

Wood Pole Deterioration and Preservation Methods.—The principal disadvantages of wooden poles are:—

- (a) Their liability to decay;
- (b) Susceptibility to destruction by termites (white ants);
- (c) Destruction by bush fires.

In Australia about 80 per cent. of pole replacements are due to decay, 14 per cent. are due to termites, and 6 per cent. to other insects, bush fires, lightning, floods, etc.

Decay is due to the growth of fungus which feeds on the wood and breaks down the wood structure. Fungus needs water to keep it alive, hence the principal seat of fungus decay is at or below the ground level, where the action of sun and wind cannot evaporate the moisture. Other places where fungus decay may occur are the cracks leading down from the top of the pole, if water is allowed to collect there, and the joints between crossarm and pole. Decay from these last two causes occurs only in moist localities where timber does not dry out thoroughly.

In order to prevent rain water lodging in the tops of poles and entering through cracks and pipes, etc., the tops of the poles are usually bevelled. There is a tendency for poles to split and crack near the top, particularly in climates where there are extremes of heat and moisture. In these localities and also those where excess

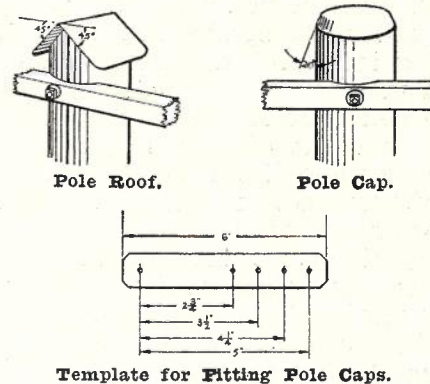

Fig. 1.—Protection of Pole Top.

moisture conditions result in decay developing despite bevelling, it has been the practice to fit pole roofs consisting of a piece of sheet galvanized iron bent along the centre and overlapping the bevel at all points (Fig. 1). These roofs are attached by galvanized spring-head nails to the bevelled surface. A recent innovation, so far as the Postmaster-General's Department is concerned, is the use of pole caps which are to be used in lieu of bevelling and fitting pole roofs. These consist of an inverted basin-shaped fitting stamped from sheet steel and galvanized. The pole top is left square and the edges bevelled so that the end of the pole is circular and the cap is fixed by galvanized nails (Fig. 1). These pole caps are more quickly fitted, less likely to come off and will provide some support against any tendency of the timber to split open.

When termites attack the poles they eat the wood, build mounds and tunnels and feed the rest of their colony. Wood-eating termites are divided into three groups, according to their habits; viz., (a) subterranean, (b) dry-wood, (c) tree dwelling. The subterranean species are the only ones which cause sufficient trouble to be a really serious menace. They are so named because of their tunnelling characteristics. To exist, the members of this species must maintain access to the ground. However, this does not prevent them from attacking all parts of the pole, either by boring their tunnels, using existing pipes or cracks, or making channels on the outside of the pole. The way to overcome trouble with this type of pest is to prevent them getting their needed access to the ground and in practice this is done by interposing a poison such as that contained in creosote oil, or arsenic.

The other species which attacks cut and seasoned timber is known as the dry-wood species,

and its activities appear to be restricted to isolated localities. This species does not require access to the soil, and sometimes attacks cross-arms and wooden spindles. In the localities where these pests are prevalent the parts subjected to attack can be treated with a suitable toxic preparation such as creosote.

Wood poles have so many advantages that it is well worth while spending money on them in overcoming their principal defects. Proper preservation processes will not only extend the life of existing poles and all new poles, but will also increase the range of suitable pole timbers by so increasing the life of less durable species that their use becomes economical. Another advantage is the reduced drain on our forest resources. Therefore there is much value in pursuing the question of timber preservation and considerable experimental work has been done by the Postmaster-General's Department in conjunction with the Council for Scientific and Industrial Research and other bodies interested in the preservation of timbers. Some seven or eight years ago a series of tests was commenced on short-lived timbers treated by various preservation methods. Test poles were set up in two different districts: one where fungus decay in timber was prevalent; another where attack by termites was known to be serious. These poles are periodically visited by representatives of all the bodies concerned and the results carefully recorded and analysed. Although tests are not complete, the experiments have progressed far enough to obtain an indication of the value of various treatments when applied to Australian timbers under Australian conditions.

Sound sapwood is as strong as the true-wood and the sapwood of eucalypts is especially suitable for some methods of preservative treatment, as it can be completely penetrated with preservative liquids. Suitable treatment will increase its durability to a level comparable with that of the true-wood and increase the service life of the pole as well as dispensing with the need for de-sapping (i.e., removing the sapwood). It also permits the use of smaller trees.

The basis of preservative treatment is to introduce some form of poison, which, while being cheap and lasting, will repel both the termites and the fungus. The experience gained by the experiments mentioned above shows that creosote oil most nearly conforms to all requirements.

There are several ways in which creosote may be applied, the object being to secure the maximum penetration possible with due regard to cost. The two methods principally used are:—

(a) Brushing or spraying, and (b) hot and cold dipping.

The former is usually the more practical, but cannot secure the penetration obtained by the latter, and therefore needs to be repeated periodically.

In addition to the actual application of creosote to the poles, it is the practice to permeate the soil adjacent to the pole with creosote.

The brushing or spraying method has wide scope in that it can be used on existing and new poles, and can be applied to all parts of them. In treating new poles the usual method is to brush or pour the creosote over the butt to a depth sufficient to ensure that when the pole is erected at least a foot of creosoted pole will project above the ground level. The creosote is applied with the butt of the pole lying over the hole in which it will be erected so that surplus creosote will flow into the hole. In cold weather the creosote should be applied hot and the application should be very thorough to ensure that it penetrates all of the interstices, both along the sides and at the base of the pole. This method of application is very much more effective if the pole is allowed to season first so that the moisture has left the pores and can be replaced by the creosote oil. For maintenance purposes, it is desirable to do the creosoting in hot weather as this dispenses with the need for heating, and, furthermore, the poles are drier and hence will absorb the creosote more readily. Approximately $\frac{1}{4}$ to $\frac{1}{2}$ gallon of creosote is poured into the

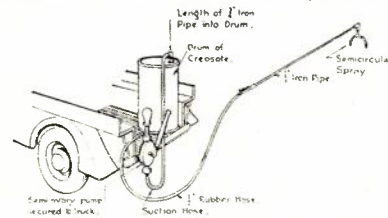

Fig. 2.—Portable Pole Creosoting Plant. Arrangement of Equipment on Line Truck.

bottom of the hole and as the soil is filled in it is thoroughly puddled to ensure complete penetration. Where convenient, a shallow trough about 1 inch deep and some 3 inches wide can be formed around the pole at the ground level. This is filled with creosote to ensure still further penetration of both soil and timber near the ground level.

For treating existing poles, a hand-spray pump is preferable, but failing this, the creosote can be applied by brushing and pouring. The butt of the pole is treated for a distance of 1 ft. 6 ins. above and 1 ft. 6 ins. below the ground level. The hole must be opened up to a depth of 1 ft. 6 ins. and all decayed timber removed until a good, clean surface is obtained. Decayed timber is of no value in the pole, and it must be cleared out from all interstices, for it not only harbours fungus, but reduces penetration of the sound timber. The creosote is then thoroughly sprayed on and poured into the hole around the pole. The hole should then be filled in, the soil puddled and the trough formed and filled with creosote as described previously. It may, in many cases, be advisable to extend the treatment

higher up the pole, particularly where there are indications of decay. In some areas it is desirable to spray the whole of the pole and there has recently been developed a form of spray (Fig. 2) which will enable this to be done. This spray consists of a series of nozzles mounted in a semi-circular piece of pipe, which is swivel-jointed to a 12 ft. length of $\frac{1}{2}$ in. pipe connected through a length of hose to a semi-rotary pump, mounted on a motor truck which carries the drum of creosote. By this means the whole of the pole, including the portion in the region of the crossarm slots, can be treated if necessary.

The hot and cold dipping process consists of dipping the butt of the pole first in hot creosote and then in cold creosote. The hot dip (which is carried out with creosote at 190 degrees to 200 degrees F.) drives off the moisture and ensures maximum penetration of the creosote, which flows readily when hot. The pole is transferred from the hot to the cold tank, where the creosote is at atmospheric temperature. While the pole is cooling the creosote is drawn into the pores of the wood, owing to the contraction occurring in the fibres. This also ensures a coating of creosote of normal viscosity which serves as a reinforcement to the thinner creosote. By this process a very satisfactory depth of penetration is ensured, and the indications are that poles so treated will have a very much greater life than untreated poles and will remain in good condition for many years without need for re-treatment. The hot dip should be carried out for a period of two to four hours, depending upon the degree of seasoning of the timber. The pole is then quickly transferred to the cold tank and allowed to remain there for four hours. This method of treatment can only be applied to new or recovered poles and usually only those in the larger centres. The method is being extended and the amount of the requisite equipment is being increased with the object of having the maximum number of poles treated economically by this process. The use of portable plants will assist by enabling this treatment to be given to poles for use on large works, the poles being delivered to convenient points along the route.

In some parts of Australia, particularly in North Queensland, where the termites are very vigorous in their attack, the toxin contained in creosote is not sufficiently severe and it has been found necessary to apply arsenic collars to the pole butts for the purpose of repelling the ants. This method has a number of disadvantages and would only be used where there are indications that the creosote treatment is not effective.

Some Factors Affecting the Durability of Wood Poles

Rate of Growth.—Fast-grown young timber is frequently less durable than slow-grown mature

timber of the same species. This may be attributed partly to a greater tendency for the pole to split and crack, partly to a greater proportion of sapwood, and a general tendency to larger pores. Hence, for untreated poles fast-grown young timber is to be avoided as much as possible. On the other hand, these factors contribute to greater penetration by preservative fluids, so that in the case of poles to be tank treated slightly younger and quicker-grown timber would be acceptable.

Denseness of Grain: There appears to be some general relationship between density and durability of the eucalypts used as pole timbers, the denser ones being the more durable. This relationship can be used only when comparing the timbers of the same botanical genus. Within a species, high density timber has in general been found to be more durable than low density timber.

Cutting Season: Contrary to the one-time common belief, the time of cutting does not affect the service life of a pole, provided the necessary care is taken of the timber after it is cut. The most important effect of the time of cutting is the influence of climatic conditions on the rate of drying of the pole. Very rapid drying immediately after felling and barking may result in excessive splitting and cracking, hence this treatment should be avoided as far as possible.

Knots, etc.: Knots, pipes and gum veins not only reduce the effective strength of the pole, but may serve as a seat for the accumulation of moisture, thus encouraging the growth of decay fungus. Each knot hole, pipe or gum vein should be examined and considered from both aspects.

Decay Pockets: Decay pockets are usually serious as the initial decay acts both as a source of decay infection and as a catchment for moisture, thus setting up conditions suitable for rapid decay development.

Seasoning: Experimental work carried out in U.S.A., using both green and air-seasoned untreated poles, has shown that the green set poles give longer life. It is probable that similar results would be obtainable with Australian timbers, and it is apparent, therefore, that there is no advantage to be gained in seasoning poles which are to be used untreated. For preservative treatment, however, seasoning is desirable.

Rainfall: Usually, in areas of heavy rainfall timber deterioration from decay is serious. With decreasing rainfall the extent of decay decreases.

Temperature: High temperatures, with high humidities as experienced in tropical areas, are conducive to rapid decay. High temperatures also are more suitable for termite activity. Excessive cold generally tends to reduce both decay and insect attack. In comparing the durability of the same or different timbers in different dis-

tricts, due consideration must be given to local conditions of climate, vegetation, etc.

Soils: Soils have a considerable effect on durability. Poles set in very wet or very dry soils will resist decay longer than similar poles set in soils which may be alternately wet or dry. The extent of vegetable matter in the soil increases the possibility of early decay, the higher the organic matter content the greater being the possibility of attack. Experience indicates that, in general, termites do not like water-logged soils or loose sandy soils, their preference apparently being for a loamy soil.

Re-use of Hole: The setting of a new pole in the hole previously occupied by a pole removed on account of decay or termite attack undoubtedly reduces the life of the new pole. Conditions of infection are very severe, the old hole containing fungal mycelium or perhaps being in direct contact with termite galleries or a termite mound. If an old hole must be re-used, an attempt at sterilization by treatment with a preservative, such as creosote oil or zinc chloride, is advisable, the liquid being poured into the hole so that all the adjoining ground is thoroughly wetted by it.

Fitting of Wooden Poles

The normal method of fitting wooden poles is to cut slots to a depth of $1\frac{1}{2}$ inches to hold each crossarm and to bevel the top of the pole to prevent any accumulation of water.

Slotting work can best be carried out on the ground as the workmen operate more comfortably, particularly in the matter of sawing; it is very difficult to operate a handsaw satisfactorily with the pole vertical, and the operator standing on the rungs of a ladder. Hence there are advantages in fitting the pole completely while it is on the ground, cutting slots for the ultimate number of arms that the pole will be required to carry. On the other hand, such slots provide a seat for moisture to collect and permit the decay fungus to develop. The proper procedure would, therefore, depend upon the climatic conditions and the type of timber. In moist, humid climates it is best to fit the pole only to suit immediate requirements, while in dry climates the saw cuts at least could be made, leaving the wood in the slot to be cleaned out when the arm is to be fitted. If this is done, it is advisable to take special care to penetrate the timber adjacent to the saw cuts with creosote.

Normally, the best pole timbers are those which grow slowly, coming mostly from areas having a moderate rainfall, but such trees do not usually grow tall and straight to form the ideal pole. It frequently happens that poles are supplied which are not perfectly straight, and this complicates the fitting, particularly if long angle iron combiners are to be used. Therefore, it is necessary that at the top of the pole at least one face be selected that is approximately

straight for the full distance over which the crossarms will be fitted. For poles which will be used for trunk line work and will, therefore, be equipped with angle iron combiners, it is frequently advisable to add a clause to the regular specification, indicating that it will be necessary to insist on reasonable straightness at the top of the pole. The following description refers to a method of dressing crooked poles, the process being similar, but somewhat simplified for straight poles. The writer has set out the order of operations with the object of ensuring maximum efficiency, consideration being given to—

(a) Carrying out all similar operations at the one time, e.g., bore all bolt holes at once, etc.;

(b) Doing no actual work on the pole until the marking of the arm slot depths is completed. It is possible with a bad pole and a slight error of judgment that it will be necessary to select another face;

(c) Avoiding duplication of work.

For efficient and accurate work an adequate kit of tools in good condition is essential. Saws, chisels, adzes and bits, etc., should be kept sharp and the saw teeth should have ample set. The kit should include the following items:—

Spirit level.	Rule.
Handsaw—6 teeth to inch.	Chalk line.
$1\frac{1}{2}$ " Firmer chisel.	Block chalk.
Carpenter's mallet.	Adze.
Claw hammer.	Brace.
$\frac{5}{8}$ " Spanners—2.	9/16" Auger bit.
$\frac{3}{8}$ " Spanners—2.	7/16" Auger bit.
11/16" Auger bit.	Timber dogs—2.
11/16" Waggon bit	Carpenter's pencil.
(for stout poles).	Draw knife.
Cant hook or turning rope.	

First, measure the length of the pole and mark its correct size. This is necessary because pole inspectors often reject poles to the length supplied by the contractor, but accept them for use as shorter poles.

Next select the arming face. This is most important and requires particular care because it may prove impossible to fit the pole properly unless a good face is selected. The arming face should be chosen so that—

(i) The whole of the arms that the pole will ultimately carry can lie in the one plane;

(ii) The bolts will pass close to the centre of the pole;

(iii) The arm bolts will tend to close any splits in the pole;

(iv) If practicable, any bow in the pole is along the line of the route.

Frequently the selection of the arming face has to be a matter of compromise between these requirements; the depth of the arm slots will vary, but none should be less than half an inch nor so deep as to seriously weaken the pole; the

bolt should pass through the slot so that there is at least 1 inch of timber in the face of the slot beyond the bolt hole. In making the selection, roll the pole completely over at least once, to ensure that the best possible face is chosen.

Cut a short log about 3 feet to 4 feet long with a V notch in it and place it under the head of the pole so as to raise the upper end of the pole clear of the ground and prevent the pole

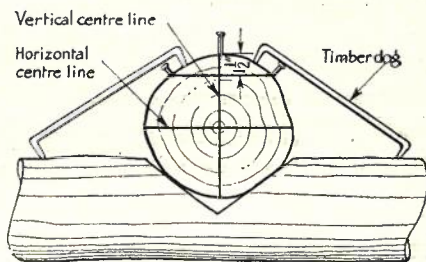

Fig. 3.—Datum Marks on Pole Top.

from rolling. If the operator is alone, or logs are not handy, the pole could be chocked.

Turn the pole over until the arming face is uppermost and secure it to the under log with timber dogs to prevent it turning during subsequent work. On the head of the pole make horizontal and vertical centre marks using a spirit level and a pencil, providing a chalk background for the pencil lines if necessary. (Fig. 3.) These lines form the basis for subsequent work on the pole and on each occasion that a spirit level is used one of these lines should be checked first with the level to ensure that the pole has not shifted.

Next strike a mean pole centre down the arming face. To do this drive a nail at the centre of the top of the pole and another at the centre near ground level. (Fig. 4.) The centre is found at this point by making a mark a distance

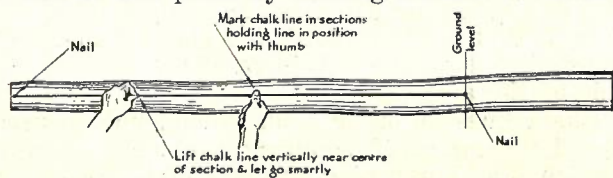

Fig. 4.—Striking Mean Pole Centre.

"a" (about half the pole width) from a spirit level held vertically, first on one side of the pole and then on the other. The pole centre will be midway between these points. (Fig. 5.) Stretch a chalk line (i.e., a piece of string on which chalk has been rubbed) tightly between the two nails, and mark the centre line carefully by drawing the chalk line taut at the centre and then letting it go suddenly (Fig. 4), thus causing it to spring against the pole and deposit chalk along the surface. This is best done in sections of about 4 feet to 6 feet along the length of the chalk line, the line being held

down with the thumb at suitable points and care being taken to pull the string out vertically from the pole so that there will be no tendency for it to spring out of its correct line.

The next stage is to mark the arm centres. The distance from the pole top to the centre of

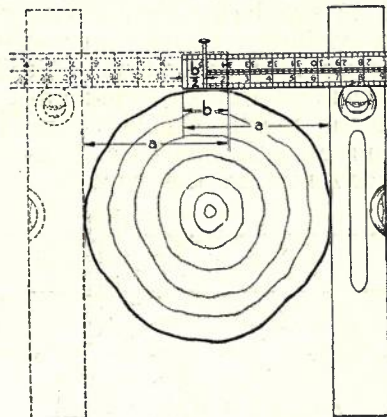

Fig. 5.—Striking Pole Centre.

the top arm should be equal to the diameter of the pole top or 9 inches, whichever is the greatest. The centres for the remainder of the arms will then be marked off along the centre-line. Usually the arms are at 14 inch centres, but on trunk routes where carrier systems will be operating the upper arms are placed at 28 inch centres. Centres for the ultimate arms should be marked out as well as for those to be fitted initially.

The depth of the arm slots should then be determined. Mark off a horizontal line on the head of the pole 1½ inches down from the arming face, drive nails in the sides of the pole at each

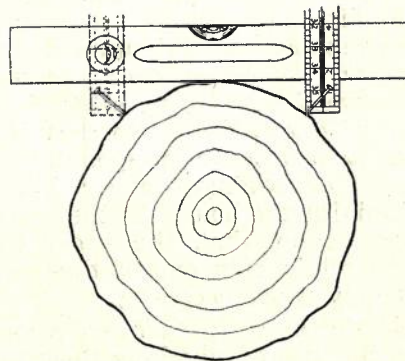

Fig. 6.—Marking Depth of Slot for Lowest Ultimate Arm.

end of the line (see Fig. 3). Mark similar points opposite the lowest ultimate arm, using the spirit level held horizontally and a rule held vertically (see Fig. 6). Drive nails in at these points and stretch chalk lines between these and the corresponding ones at the head of the pole. Normally, these lines will indicate the depths of the slots, but on a crooked pole it may be necessary to check with a spirit level (Fig. 7), that none of the slots will be less than ½ inch deep nor so

deep that they will seriously weaken the pole. If either of these conditions is met with, raise or lower both lines so as to conform to the requirements; with a particularly difficult pole it may be found necessary to reduce the slot depth at the lower end and increase it at the head so as to avoid cutting too deeply into the pole in the vicinity of the lower arms, where greater strength is necessary. (See Fig. 8.) When the position for the chalk lines has been determined the marks should be made on the pole. In this case the marks and the chalk line must be horizontal so the wire is pulled hori-

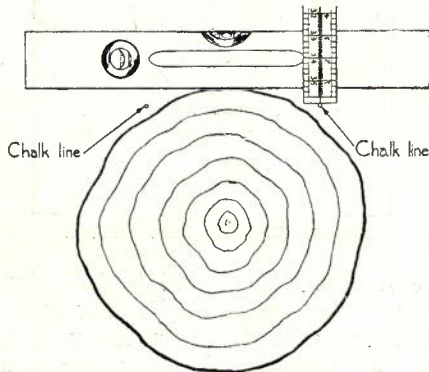

Fig. 7.—Checking Depth of Slots for Intermediate Arms.

zontally, the marking being done over short sections as in the case of the centre-line. To be of value this marking needs to be done very carefully.

Carefully bore the holes for the arms to be fitted originally, using an 11/16 inch auger bit, and keeping a close watch to see that the tool is held straight so that the holes are perpendicular to the arming face. When boring, take care to prevent the bit from choking. The bit will free itself much better if a light upward pressure is maintained on the brace once the worm has entered the wood. At about every 2 inches of penetration withdraw the bit to clear it of shavings. For stout poles a waggon bit, which is longer than the ordinary auger bit, may be required to finish the hole. As these are usually scarcer and dearer than the auger bits, it is advisable to retain only one of them in the kit and use it only when necessary.

Assemble the arms to be fitted alongside one another on the ground, checking them for length, bends and regularity of distance to bolt holes, etc. Arms with a bow in them should be fitted so that the ends bend upward or outward from the pole, depending upon the face that is bowed. If arms are of unequal length assemble them, if practicable, so that the longer ones are at the top and taper down to the shortest at the bottom. If there is any marked irregularity, cut the arms to the correct length or exchange them. The requirements are that the arms shall be a driving fit in the slots so that when cutting the

slots it is advisable to cut them to fit the individual arms selected for them; each arm to be fitted initially should, therefore, be marked with a number to indicate its position and also an arrow or other suitable mark to show which is the upper surface. These precautions are advis-

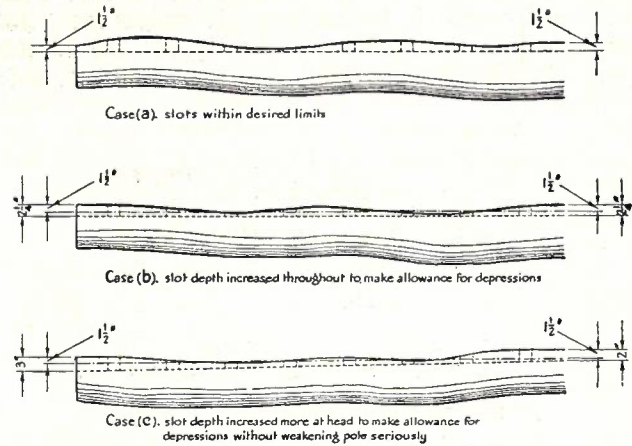

Fig. 8.—Setting Depths of Arm Slots.

able because of any irregularity which may occur in the width of the individual arms, and also in the boring of the bolt hole in the cross-arm.

Now make the marks for the sides of the arm slots. To do this rest each arm in its position on the arming face with a bolt passing through it and through the bolt hole in the pole. The arm is then adjusted so that it is square with the centre line. This is done by means of a measuring wire attached to a nail on the centre line some 6 feet to 10 feet down the pole and measuring to points marked near each end of the crossarm that are equi-distant from the centre pole. The wire is held first on the mark on one end of the crossarm and then at the other and the arm moved until the distance from the nail to either mark is the same. With the arm in this position, mark the slot by means of a chisel, holding the blade carefully against the side of the arm.

Chalk lines or other cords should not be used for the purpose of squaring the arm, as cord stretches and may give different distances under different tensions. A suitable measuring wire for use in the pole fitter's kit can be made up from a thin flexible wire rope or a piece of 7/20 stay wire; an eye splice is made at one end for fitting over the nail while 10 turns of 50 lb. soft copper makes a marker that can be shifted along the wire to meet the marks on the arms. If slots or saw cuts are to be provided for the balance of the arms, the saw cuts should be made a neat 3 inches apart and equi-distant from the bolt hole centre. Such marks can conveniently be made with a template of the type illustrated in Fig. 9. This device is also suitable for marking slots for arms that are unevenly

bowed, as it is advisable to make the arm slot square to the line of the pole and to pull out the bend when attaching the arm to the combiner.

Now cut the sides of the slots with a hand saw, taking care to see that the saw is held with the blade vertical, that the guide marks are just left on and the saw cuts stop about $\frac{1}{16}$ inch short of the depth marks.

With firmer chisel and carpenter's mallet clear the unwanted timber from the slot, making the final clearance carefully to ensure that the arm will fit squarely against the pole and parallel to the plane of the arming face. This can be checked with a spirit level.

The back of the pole has now to be scarfed so that the washers under the head of the bolt will sit evenly on the true-wood. In the past this scarfing was usually carried out only in the

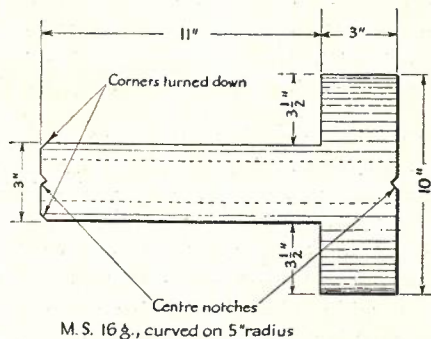

Fig. 9.—Template for Marking Sides of Arm Slot.

region of the bolt hole, but the present-day practice is to cut a straight scarf for the full distance of the arms. Turn the pole over on its side and check the marking at the head with the spirit level, which can then be used to check the scarfed face. The depth of the scarf should now be marked out with a horizontal line at the head, and side lines provided in a similar manner to that used for marking the depth of the arm slots. Use an adze to take off most of the timber and finish with a draw knife or even a jack plane.

The next operation is to trim the top of the pole. This may consist of (a) bevelling, or (b) capping. Method (a) consists of cutting the bevel with sides at 45° to the centre line and with the ridge running in the same direction as the line wires. Turn the pole on its side, and mark a point thereon that is down from the head of the pole a distance equal to half the diameter of the pole top. Cut the faces of the bevel with an adze, using a straight-edge as a guide in obtaining a flat face between the mark on the side of the pole and the ridge.

In using the adze special care is necessary, as there have been a number of bad accidents occur through the tool glancing off a chip and entering the operator's leg or foot. The method of using the adze is illustrated in Fig. 10, and it

will be noted that the hands are held in such a way that the travel of the head of the adze is limited by the operator's arms bearing against the knee in one case and the inside of the thigh in the other case.

Method (b) consists of fitting a pole cap. This fitting has been introduced recently, and is intended to seal effectively the top of the pole,



Fig. 10.—Cutting Bevel with Adze.

preventing splitting and penetration of the pores and crevices with water. The pole cap used should be a neat fit for the pole, and the only dressing required is to make a slight chamfer to enable the cap to fit neatly over the pole. The latest design of pole cap has a tapering side (20° taper) and is supplied in four sizes of the following diameters: $5\frac{1}{2}$ ", 7", $8\frac{1}{2}$ ", 10".

These diameters are measured at the top of the taper. For fitting the cap a guiding circle on the head of the pole will be found useful. This can be marked by means of a template consisting of piece of hoop iron about 6" long with a $\frac{1}{8}$ " hole half an inch from one end and four $\frac{1}{8}$ " holes near the other end, so set out that they are distant from the first hole—an amount equal to half the diameters of each of the pole caps. (Fig. 1.) A nail is passed through the hole at one end and driven into the centre of the pole top, while another nail is pushed through the appropriate hole at the other end of the plate, which can be rotated to scribe a circle of the required diameter.

While the pole is on its side, pass the bolts through the bolt holes and turn the pole on its back again, levelling it afresh with the spirit

level held against the line at the head of the pole. Insert the arms in their proper slots and check them to ensure that they line up correctly. Any adjustments that are necessary can be made at this stage.

The next consideration is the fitting of the arm braces, etc. On subscribers' construction two 18" arm braces are usually used on each arm. These are secured to the pole by means of the arm bolt holding the arm below, except in the case of the lowest arm, where a 3" x $\frac{5}{8}$ " coachscrew at 14" centre is used. The ends of the braces are fastened to the arms by 3 $\frac{1}{2}$ " x $\frac{3}{8}$ " bolts passing through 7/16" diameter holes bored through the centre of the arm.

On trunk poles 41" arm braces and angle iron combiners are fitted. The fitting is best carried out in the following way:—

(a) At a point 28" below the lowest arm bore a hole to take a 3" x $\frac{5}{8}$ " coachscrew (this will usually be made with a $\frac{5}{8}$ " diameter bit for a distance of about 1" and a 9/16" diameter bit for a further 2").

(b) Attach the lower ends of the 41" braces to the pole by means of the coachscrew.

(c) Mark the combiner bolt hole along the centre of the bottom arm and bore it with a 7/16" auger bit.

(d) Bolt the upper ends of the braces and the lower ends of the combiners to the bottom arm.

(e) Mark holes along the top arm equidistant to those on the bottom arm and bore them for combiner bolts.

(f) Pass a combiner bolt through each of these and fit the combiner over it. Now mark the positions for the combiner bolt holes in the intermediate arms.

(g) Shift the combiners clear and bore the holes for the intermediate arms. These holes should take the vertical alignment of the combiner, but pass through the centre of the arm.

(h) Assemble the combiners to the arms, using a twitch in a rope to pull a bowed arm into position if necessary.

Pre-slotting: Pre-slotting of poles by means of a machine has been carried out in Sydney, and to some extent in Melbourne, but has not been put to any very extensive use elsewhere. This method is in some circumstances much cheaper than the hand-slotting method, but its scope is limited to poles which pass through

depots in sufficient quantity to justify the cost of a machine of this type. The method also has the disadvantage that a standard width of arm must be assumed and any variations from this width will involve either a loose fit in the slot or additional work to make the arm fit.

Scarfig: Over the past few years trials have been made of a method of fitting the arms to poles by scarfig a flat face down the full length of the dressing face so as to expose some 3" or 4" of true-wood and dispense with the slots altogether. This method has been claimed to decrease the time required for dressing and also to reduce the accumulation of moisture in crevices formed between the pole and the crossarm. Trials made so far indicate that this method has advantages, but they are not actually very great. In some instances the scarfig has proved to be quicker, whilst in others it has not—depending upon the ability of the operator to use an adze. Furthermore, there is the objection to this method that with the pressure of the bolt alone there is not sufficient friction between the arm and the pole to enable the arm to support the weight of the workmen until combiners or braces are fitted; possibly some simple and economical means of increasing the friction between the arm and the pole can be devised. One method which has been adopted is to fit the braces to the bottom arm and temporarily tie the arms together on one side of the pole by means of rope. From the results and experience gained during these trials, indications are that the most satisfactory way might be to fit the arms to the poles by means of slots cut shallower than the 1 $\frac{1}{2}$ ", which is present standard practice. The 1 $\frac{1}{2}$ " slot does not appear to be necessary and has disadvantages in that it takes more time to cut, as well as reducing the strength of the pole. It is possible that a change will finally be made to this effect, reducing the depth of the slots to a minimum of $\frac{1}{2}$ ", but making them sufficiently deep to ensure that the arm will bear upon true-wood over a face at least 1" wide.

(To be continued.)

Bibliography

"The Selection, Preservation, Distribution and Identification of Australian Pole Timbers"—C.S.I.R. Pamphlet No. 55.

"Timber in the Telephone Service"—B. McMahon, D.P.A., A.M.I.E.(Aust.) — P.E.S. Printed Paper No. 15.

INFORMATION SECTION

Readers are invited to submit questions on either theoretical or practical aspects of Telecommunication Engineering. Answers will be published in this section.

THE HYBRID COIL

The hybrid coil (sometimes termed a 3-winding transformer, a differential transformer, or a terminating unit) provides a means of separating and combining the two directions of transmission. It performs a function analogous to the duplex equipment in telegraphy and a clear understanding of its action is necessary in order to appreciate the operation of equivalent 4-wire working in telephony. In the following notes the operation of the hybrid coil is briefly treated in a non-mathematical manner:—

A hybrid coil may be of the unbalanced or balanced type. In the unbalanced type the windings are in one side of the line only, whereas in the balanced type these windings are divided into two halves, one half being placed in each side of the line.

An unbalanced type hybrid showing the method of combining the 2-wire circuit to the equivalent 4-wire circuit is shown in Fig. 1.

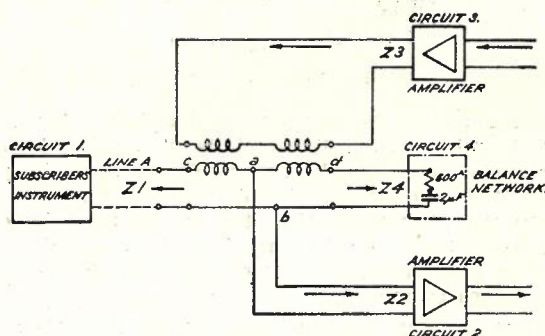

Fig. 1.

The impedance Z_4 is an artificial electrical network designed to match the combined impedance of the line A and the subscribers' instrument at all essential frequencies.

The term "essential frequencies" means the band of frequencies in use on the particular circuit. In the general case it refers to the voice frequency range of 200 to 2600 cycles per second, but in some instances, e.g., balanced carrier systems, the term might mean a band of carrier frequencies.

In Fig. 2 the hybrid coil is replaced by a square within which is indicated the various transmission paths which exist under ideal conditions of equality of opposite impedances. Between each two adjacent impedances the equivalent of the transmission path is 3 db., whilst between opposite impedances the transmission loss is infinite. When one pair of opposite impedances is not similar, the transmission loss between the other pair is reduced to an extent depending on the amount of dissimilarity.

Transmitting Direction.—Considering power delivered from Circuit 1 into the hybrid coil if the balance network is a perfect match for the line and its termination, then the power will divide equally between Circuits 2 and 3. In other words, there will be a 3 db. loss of power in going from the line to Circuit 2. This half of the power will be amplified by the transmitting amplifier and transmitted to line. The remaining half of the power which passes into Circuit 3 is

dissipated in the anode circuit of the receiving amplifier and does not cause any harmful effects.

No power is delivered to Circuit 4 in this condition. Assume temporarily that Z_4 is disconnected, leaving the terminals b, d open. If the value of Z_2 is such that the impedance between terminals c, a, is equal to Z_2 , then the potential difference between c and a will

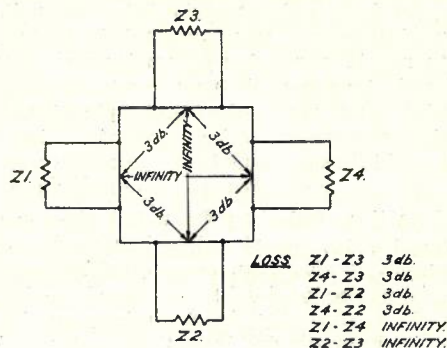

Fig. 2.

be equal to that between a and b. The potential difference between c and a is also equal to the voltage induced in the winding ad, since the latter interlinks the same flux as c, a. The potential between terminals d and b is, therefore, zero and no current flows in Z_4 when it is connected again to the transformer, hence the transmission loss between Z_1 and Z_4 is infinitely large if the turns ratio, and impedance ratio of Z_2 and Z_3 are such that equal power is dissipated in each.

Receiving Direction.—Amplified power from Circuit 3. Provided that Z_1 equals Z_4 the power will divide equally at the points a, b, half going to the line and half to the balance network, the latter half being dissipated in the net. Considering current at either point a or b under these conditions, it will divide equally and flow in opposite directions through each half winding so that, in this condition, no power will be delivered to Circuit 2.

The operation of the hybrid coil is not affected if the connections to the input and output circuits are interchanged and in practice either arrangement is employed.

This will be appreciated if the reversed case is considered, i.e., amplified power delivered from Circuit 2 to the hybrid coil. Provided the previously mentioned conditions for Z_1 and Z_4 and the transformer windings are met, the power will divide equally at points a, b and half will be delivered to the line and half to the balance network. Considering current at points a or b, the division will again be equal and opposite in each half winding so that no power will be delivered to Circuit 3 in this condition.—J.L.S.

A METHOD FOR RECONDITIONING THE CASES OF HANDSET TELEPHONES WHICH HAVE BEEN RECOVERED FROM SUBSCRIBERS' PREMISES

With the introduction of phenolic moulded products, methods had to be established for the reconditioning of such items, telephone cases, handset bodies, etc.

The trade practice is to subject parts to a light buffing. For removing light "flash" from mouldings, a fast cutting mop is used with "Lustre Tripole." For finishing work a mop of the Swansdown variety is used "dry" (without polishing composition).

Whilst this method is satisfactory for items of regular form, it did not meet the requirements for telephone equipment, especially handset telephones with the associated cordage. With buffing, it is essential that all cordage be removed and to adopt the trade practice it would be necessary to have a separate polishing head or arrange for the changing of one type of mop to another.

Great care has to be exercised in the polishing of plastic mouldings, as once the polish is burnt it is difficult to regain a regular or uniform surface.

Most handsets returned for reconditioning are dirty due to drainage from the mouthpiece and grease marks, also surface scratches are often in evidence. In order to establish a simple method of treatment for bakelite surfaces, the following practices were tried:—

(i) **The Use of Carbon Tetra Chloride on a Pad.**—

It removes grease marks, but has tendency to dull the surface, it also evaporates quickly.

(ii) **The Use of Methylated Spirits.**—It removed grease stains, has a tendency to drag on the surface.

Whilst both methods left the surface clean, as neither would remove surface scratches, it was obvious that some abrasive was required.

(iii) A paste was prepared utilising Calcium Carbonate as a base with a proportion of Carbon Tetra Chloride for removal of grease and a small proportion of Methylated Spirits to slow the action of the Tetra Chloride. This paste, rubbed on to the moulding, cleans the surface and in addition removes surface scratches. The surface is then brushed off with a soft brush, which leaves a finishing polish. This method has proved satisfactory in practice. The paste has no deleterious effect on the cordage, therefore it is unnecessary to remove the cords, as paste which lodges thereon does not stain and can be readily brushed off.—F.I.McC.

THE METHOD OF FEEDING BATTERY TO A RINGING DYNAMOTOR IN AN AUTOMATIC EXCHANGE

In modern automatic telephone exchanges, ringing current and the various tones are supplied by a generator driven by an A.C. motor. It is important that ringing current should not fail, so a standby dynamotor driven from the 50V. exchange battery is provided. This dynamotor is started automatically on failure of the ringing current.

The point of interest is that the main battery feed to the dynamotor through the "A" contacts of the automatic changeover switch (see Fig. 1) is duplicated by a battery feed taken to the start button. The effect of this arrangement is that once the dynamotor is started it will continue to run independently of the changeover switch "A" contacts, or, in other words, does not stop automatically when the A.C. driven ringer is restored to the load. It can be stopped by an operation of the stop button, but if this operation is omitted the dynamotor may run for some time without being noticed, because it runs very silently and there is no alarm.

Referring to Fig. 1 for a brief description of the operation of the automatic starter:—

When ringing current fails, contact A.A2 closes and battery is fed through relay S to earth. S contacts feed battery from both leads to the field F and armature M of the motor. At this stage the armature has resistance, R and the two opposed windings of relay P in series and current is limited, but is still high enough in Z winding to prevent P from operating. As the speed builds up the back e.m.f. in the motor reduces the current through it until relay P is dominated by the current through the Y winding, which has a battery feed parallel to the field and armature supply. P then operates and

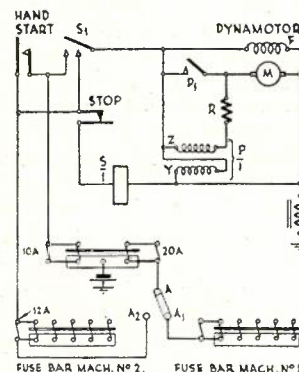

Fig. 1.—Dynamotor.

its contact P1 shorts out resistance R and Z winding of P relay and full speed is attained. If A.A2 contacts are opened, the duplicate feed keeps S operated and keeps the dynamotor running. To stop the dynamotor, the stop button must be operated to open the battery feed to the "S" relay. When S releases, the battery feed to the field and armature is opened.

Automatic stopping can be given if both fuses in the duplicate battery feed are removed. This, in effect, means disconnecting the duplicate feed. However, by doing this, the facility for starting the dynamotor while the A.C. driven machine is running would not be available. This facility seems desirable and should not depend on fuses (which may be mislaid) being replaced.

If it is desired to provide against the possibility of the dynamotor being left running, it would not be difficult to connect an alarm relay off the machine 2-fuse bar. The alarm, in the form of a lamp on the control panel, glowing while the dynamotor is running, would be quite satisfactory.

With regard to the fusing arrangements, the main feed to the "A" contacts has a 20 amp. cartridge fuse for protection, while the duplicate lead has a 10 amp. cartridge fuse. The higher fuse rating in the main lead is necessary because this lead also supplies battery to the fuse bar for the tone generators. A 12 amp. cartridge fuse is nevertheless supplied in parallel with the machine No. 2 fuse panel and in series with the 20 amp. fuse. Adequate protection is thus provided for the dynamotor.

For a general description of the operation of inductor type ringing generators, the reader is referred to the article entitled "Ringing Machines and Inductor Tone Generators for Telephone Exchanges," Vol. 3, No. 1, page 33.—D.F.B.

ANSWERS TO EXAMINATION PAPERS

The answers to examination papers are not claimed to be thoroughly exhaustive and complete. They are, however, accurate so far as they go and as such might be given by any student capable of securing high marks.

EXAMINATION NO. 2256.—MECHANIC, GRADE 2, TELEGRAPH MAINTENANCE SECTION

H. R. WADDELL

Q. 1.—Show, with the aid of a diagram, the circuit of a Duplex repeater used for repeating between a physical line and a carrier channel. Briefly explain its operation.

A.—Fig. 1 shows the schematic circuit. The physical line is terminated on a differential polarized relay in the normal manner for differential duplex working, the artificial line AL balancing the physical line.

The tongue of the differential relay responds only to the sending key at the far end of the physical line

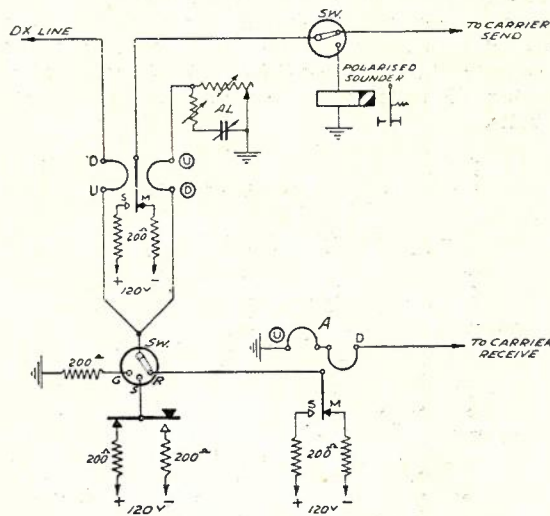

Q. 1, Fig. 1.

moving to marking or spacing according to the position of that key. The tongue of this relay is connected to the sending circuit of the carrier send channel and the signals incoming from the physical duplex line are thereby passed on to the carrier channel.

Signals incoming from the carrier channel are received on the polarized relay A, the tongue of which moves to marking or spacing according to the incoming signals. The tongue of relay A is connected to the split of the differential line relay and thereby signals incoming from the carrier channel are passed to the far end of the physical duplex line.

By means of the switches SW a pole changer and receiving sounder may be connected to send and receive over the duplex physical line with the carrier circuits disconnected. To send and receive over the carrier system alone a double current key and a polarized sounder is patched to the carrier send and carrier receive leads respectively in place of the repeater.

Q. 2.—Calculate the gears which could be used to screwcut a thread of 14 threads per inch on a lathe with a lead screw of 4 threads per inch. Explain how you would proceed to set up the gears, using sketches to illustrate your answer.

A.—The rule for a simple gear train is:—

Number of threads per inch on lead screw

Number of teeth in driver gear

Number of threads per inch to be cut

Number of teeth in lead screw gear

This fraction is $4/14$ and a suitable equivalent fraction is $20/70$.

That is, the required gearing is:—

Driver gear 20 teeth

Lead screw gear 70 teeth

The sketch, Fig. 1, shows the arrangement of the gears on the lathe. The driver gear is keyed to the lathe mandrel and the lead screw gear is keyed to the lead screw. An intermediate or idler gear is placed on a stud set in the slot of the swing plate so that it

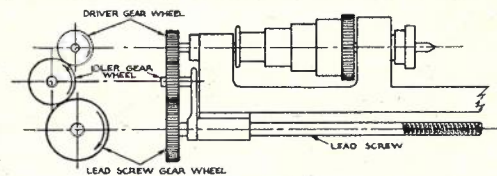

Q. 2, Fig. 1.

meshes with both driver and lead screw gear. The idler gear may be of any convenient size as the number of teeth on this gear do not affect the overall gear ratio of the train. With the gears arranged as shown in the sketch the thread cut would be right-handed. If a left-handed thread was required it would be necessary to use two idler gears in series to reverse the direction of rotation of the lead screw relative to the mandrel.

Q. 3.—What is meant by the terms "polarized" and "differential" as applied to a telegraph relay? Draw a telegraph duplex circuit in which it is necessary to use a differential polarized relay.

A.—A polarized telegraph relay is one in which the magnetic circuit is polarized by means of a permanent magnet. Polarized relays are more sensitive than their non-polarized counterparts and have the characteristic that the direction of movement of the armature whether to

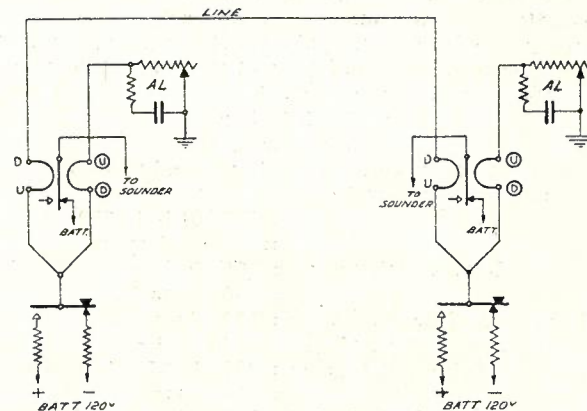

Q. 3, Fig. 1.

marking or spacing depends upon the direction of the current through the windings. The Creed 27V relay is an example of a polarized telegraph relay. If the

armature tongue of this relay is adjusted neutral it will remain on the contact stop to which it was last operated; the polarized magnet retaining it in that position until a current flows through the windings in the reverse direction.

A differential telegraph relay is one in which there are two windings (or two sets of windings) each having the same resistance and the same magnetic effect upon the magnetic circuit when equal current is flowing through them. One winding is connected to the terminals U and D, and the other winding to terminals U circle and D circle. The armature is unaffected when a current of the same value passes through one winding in the direction U to D and through the other in the direction D to U.

Fig. 1 is the schematic diagram of a duplex telegraph circuit in which the relays are differential polarized types.

Q. 4.—In the following circuit, calculate the voltage which must be applied at X to pass a current of 30 milliamps through the relay "A." (The resistance of the earths and the internal resistance of the battery may be neglected.)

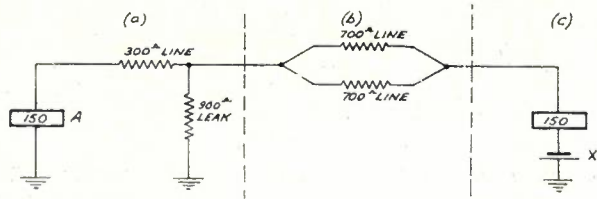

A.—To simplify the problem the circuit given in the paper is divided into three sections: (a), (b) and (c) as shown above.

Considering section (a): Relay A is in series with the 300 ohm line

∴ Resistance of this path = 150 + 300 = 450 ohms.

The 900 ohm leak is in parallel with this 450 ohms

∴ Joint conductance of section (a)
 = $1/900 + 1/450$
 = $(1 + 2)/900$
 = $3/900$ Siemens (previously mhos)

and joint resistance
 = $900/3$
 = 300 ohms.

The total current divides between the two paths according to the conductance of each. The current through the 450 ohm path is 30 milliamps and the conductance of that path is $\frac{2}{3}$ of the joint conductance.

∴ Total current = $\frac{3}{2}$ of 30
 = 45 milliamps
 = 0.045 amperes.

Considering section (b): Joint conductance of the 700 ohm lines in parallel

= $1/700 + 1/700$
 = $2/700$ Siemens
 and joint resistance = $700/2$
 = 350 ohms.

Resistance of section (c) = 150 ohms.

Sections (a), (b) and (c) are in series

∴ Total resistance = 300 + 350 + 150
 = 800 ohms.

Voltage applied at X is given by Ohms Law $E = IR$

∴ Voltage = $0.045 \times 800 = 36$ volts.

Q. 5.—Explain with the aid of sketches the function of a rotary switch provided at a main telegraph office where secondary cells are installed.

A.—To provide the various line voltages required at a main telegraph office using secondary cells the line batteries are arranged in groups of 20 cells as shown in Fig. 1. Under these conditions the current drain on

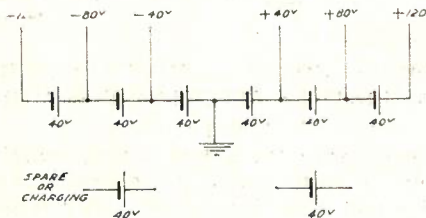

Q. 5, Fig. 1.

each group is not even, being greatest on the inner group with the 40 volt taps and least on the outer group with the 120 volt taps. To even up the ampere hour drain on the groups of cells, and also to provide a means for connecting any group to the generator for charging, a rotary switch is provided for the positive groups and another for the negative groups of cells. This rotary switch has four positions by means of which each group of 20 cells is connected successively in the positions—on charge or spare, supplying 40 volts, supplying 80 volts, and supplying 120 volts.

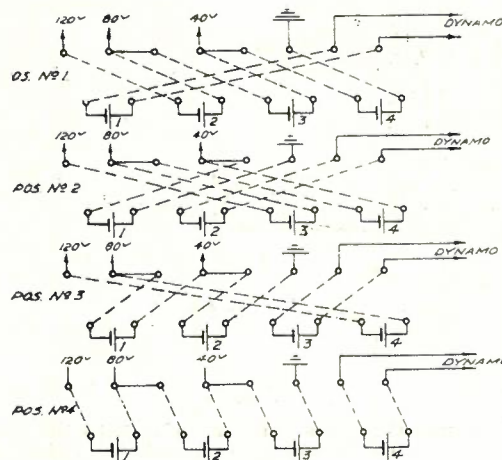

Q. 5, Fig. 2.

Fig. 2 shows schematic circuits of the rotary switch in each of its four positions.

Q. 6.—Draw the schematic circuit of a local point to point teleprinter installation, and explain its operation. Monitoring and observation facilities need not be shown.

A.—The schematic circuit of a local point to point teleprinter installation is shown in Fig. 1. In the sketch the electro-magnet of the teleprinter receiving unit at each lessee's premises is designated EM. The tongue and marking and spacing contacts shown at the lessee's premises are those of the transmitting unit of the teleprinter. With the transmitting unit at rest the tongue remains on the M contact as shown. In this condition the circuit of the U circle D circle or operating windings of the relay at the C.T.O. is open. The line resistances are adjusted by means of inserted resistance spools so that when either of the teleprinter transmitter tongues is on spacing (i.e., grounded) the current through the operating windings of the relay is 30 milliamps. The resistance R associated with the DU or bias windings of the relay is adjusted so that

the current through those windings is 15 milliamps. While the transmitter tongues remain on the M contacts the 15 milliamps through the bias windings keeps the tongue of the relay on the marking contact thus

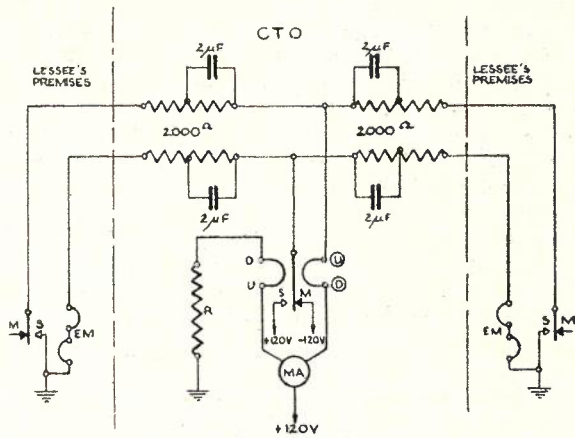

Q. 6, Fig. 1.

applying negative battery to the two receiver magnets. When either of the transmitter tongues moves to the spacing contact the preponderance of current in the operating windings of the relay moves the relay tongue on to the spacing contact thus applying positive spacing battery to the two receiver magnets. The armatures of the two receiver magnets move to marking or spacing according to marking or spacing battery applied to them by the relay at the C.T.O. Thus signals sent by either transmitting unit are received by both receiving units.

Q. 7.—What is the effect of capacity on a telegraph line? Explain how the characteristics of a telegraph line are "balanced" for duplex working.

A.—The effect of capacity on a telegraph line is that the speed at which signals can be sent is reduced. This is brought about by the fact that when battery is applied to the line the full value of the current is not received at the other end until the capacity of the line is satisfied and when the battery is removed current continues to flow at the receiving end until the line capacity is discharged. The result of this is that the speed of working is reduced; the larger the capacity the lower will be the speed of working.

For duplex working the capacity and resistance of the line are balanced by means of an artificial line or network of condensers and resistances.

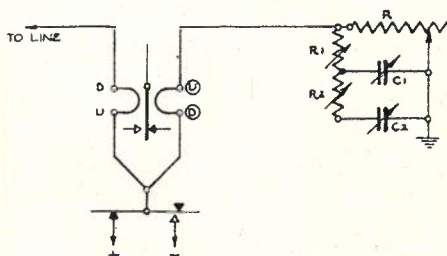

Q. 7, Fig. 1.

Fig. 1 shows the arrangement of the circuit. The resistances and condensers are variable so that their values can be adjusted to suit the line conditions. The resistance R balances the line resistance while the condensers C1 and C2 balance the capacity of the line. The resistances R1 and R2 are for the purpose of making the condensers C1 and C2 charge and

discharge at the same rate as the line capacity charges and discharges. With the far end of the line earthed, and the resistances and condensers of the artificial line network correctly adjusted, the signal currents resulting from the movement of the key will be of the same value and wave shape in both windings of the relay.

Q. 8.—Briefly explain the construction and use of any type of micrometer gauge with which you are familiar. Use sketches to illustrate your answer.

A.—A common type of micrometer caliper gauge for measuring external dimensions to one-thousandth part of an inch is shown in part cut away view in the sketch, Fig. 1. Referring to the sketch the enclosed end of the spindle is provided with a fine precision thread engaging with an internal thread in the sleeve. The sleeve is slotted at the end and provided with an enclosing nut for the purpose of taking up wear and slack in the thread. The spindle is attached to the thimble and ratchet stop so that by turning the thimble or ratchet stop the spindle is moved towards or away from the anvil. The travel of the spindle is limited to one inch. A clamp ring is provided to bind the spindle if it is desired to retain any particular setting.

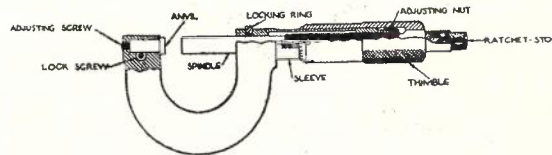

Q. 8, Fig. 1.

Adjusting and locking screws are provided to adjust the position of the anvil to compensate for wear of the measuring faces. The ratchet stop is arranged to slip with a small back pressure on the end of the spindle, thus ensuring that the same pressure is applied in making a measurement, irrespective of the touch of the person using the caliper. The ratchet also guards the caliper thread from undue straining.

The pitch of the thread on the spindle is one-fortieth of an inch (i.e., 25 mils) so that for each revolution the spindle moves that distance. Lines are marked on the sleeve at intervals of 25 mils and each fourth line is figured as shown in Fig. 2. These figures therefore represent tenths of an inch or hundreds of mils and are exposed successively by the thimble as the caliper is screwed open. The bevelled edge of the thimble is graduated in twenty-fifths of its circumference and figured at convenient intervals. Turning

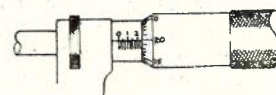

Q. 8, Fig. 2.

the thimble one-twenty-fifth of a revolution will move the spindle $1/25$ of $1/40 = 1/1000$ inch. The graduation marks on the thimble, therefore, represent mils of opening which must be added to the reading on the sleeve when taking the setting of the caliper. Fig. 2 shows the caliper set at 0.245 inch. When the caliper is fully closed all graduations on the sleeve are covered by the thimble and the zero mark on the thimble is opposite the horizontal line on the sleeve.

In using the micrometer caliper to measure, say, the diameter of a small rod, the caliper is held lightly at right angles to the rod with the rod between the anvil

and the end of the spindle. The caliper is then closed on the rod by turning the ratchet stop until it slips and the reading noted. Before making the measurement the caliper should be screwed fully closed to check for any error in the zero reading so that it may be corrected or allowances made in the readings when making measurements.

Q. 9.—Draw the circuit of a Wheatstone bridge and explain how the bridge would be used to measure the resistance of a coil.

A.—Fig. 1 shows the schematic circuit of a Wheatstone bridge. To measure the resistance of the coil X the ratio arms P and Q are set to convenient values, key K1 is closed, and the variable resistance R is varied until there is no deflection of the galvanometer

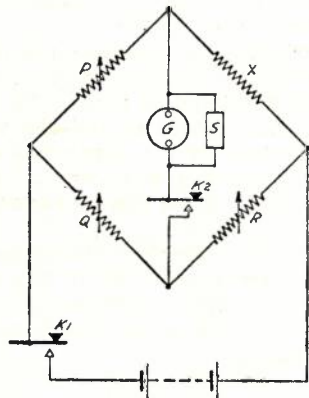

Q. 9, Fig. 1.

G when key K2 is closed. In this condition the bridge is said to be balanced and the resistance of X is given by the equation:

$$X = PR/Q \text{ ohms.}$$

Usually the ratio arms P and Q are set at equal values if the resistance of X is within the range of the variable resistance R. It is best to set P and Q at 1000 ohms if X is a high resistance and at 10 ohms if X is a low resistance.

The galvanometer is a sensitive type and to avoid excessive deflections an approximate balance is first obtained with the shunt S on the galvanometer set at a low resistance. The resistance of the shunt is then increased and the balance refined in stages until finally the bridge is balanced with the shunt at unity value. Key K1 is closed before K2 to avoid disturbing the galvanometer by the effects of the inductance if an induction coil is being measured.

Q. 10.—With the aid of sketches, describe the construction of a Morkrum Teletype receiving unit governor, and explain how the speed is kept constant.

A.—The construction of a Morkrum Teletype receiving unit governor is illustrated in Fig. 1; (a) shows

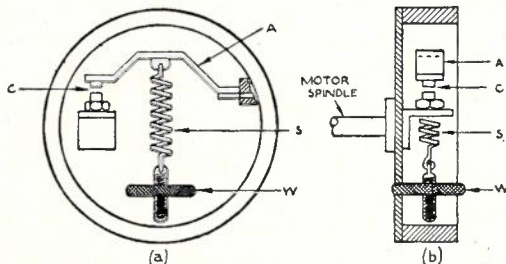

Q. 10, Fig. 1.

the end view and (b) the side view in section. The governor is mounted on the end of the driving motor

spindle and, therefore, rotates with the motor armature. The spring S is in tension tending to keep the contacts C closed, but because the governor assembly is rotating, a centrifugal force acts on the contact arm A tending to open the contacts. The centrifugal force increases with the speed of rotation so that by suitably adjusting the tension of the spring, by means of the adjusting wheel W, the contacts can be made to open at any particular speed desired.

The governor contacts are connected in the power supply to the motor as shown in Fig. 2. The motor is a DC series motor and, with the resistance lamp RL short-circuited by the governor springs, tends to run at

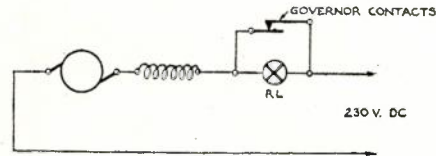

Q. 10, Fig. 2.

a speed greater than required. When the motor reaches the required speed the governor contacts open, placing the resistance lamp in series with the motor. This reduces the speed of the motor, which in turn causes the governor contacts to close. Consequently when running the governor contacts are opening and closing intermittently and the speed is kept substantially constant.

EXAMINATION NO. 2300—SENIOR MECHANIC TRANSMISSION

J. L. SKERRETT

Q. 1.—A non-inductive resistance of value R ohms, a condenser of capacity C farads, and an inductance of L henries are connected in series across alternating current supply mains of voltage V and frequency f cycles per second.

State what you understand by the terms: (a) Impedance, (b) Power Factor, and (c) Resonant Frequency of this circuit. Give mathematical formulæ in support of your explanation.

A.—(a) When a circuit possesses inductance it sets up an E.M.F. which tends to limit the current and it is usual to treat this effect as a resistance.

$$\text{The ratio } E/I = \omega L$$

$$\text{where } \omega = 2\pi f$$

L = inductance in henries
f = frequency in cycles per second.

The quantity ωL is termed inductive reactance.

The current taken by a condenser is

$$I = \omega CE$$

where C is the capacitance in farads.

$$E/I = 1/\omega C$$

and this is termed the capacitive reactance.

The reactance components therefore vary with frequency.



Q. 1, Fig. 1.

In the series circuit of Fig. 1 there will be a voltage drop due to the total resistance and a voltage drop due to the total reactance. In the general case, the resultant voltage drop will be greater than either of these components and the resultant total opposition

of the circuit to the flow of current is called its impedance. The impedance may thus be defined as the ratio of the apparent voltage to the current, i.e., impedance $Z = E/I$.

The impedance is not the arithmetic sum of the resistance and reactance for the voltage drops are not in phase. The voltage across the resistance will be in phase with the current but that across both the inductance and the capacitance is 90° out of phase, the current lagging in the former case and leading in the latter. The voltage across the capacitance is thus 180° out of phase with that across the inductance.

The conditions are illustrated in the vector diagram of Fig. 2.

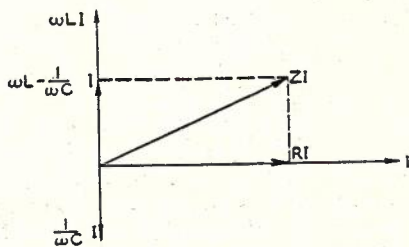

Q. 1, Fig. 2.

I represents the current,
 RI —the voltage across the resistance,
 ωLI —the voltage across the inductive reactance,
 $(I/\omega C)$ —the voltage across the capacitive reactance,
 ZI —the resultant voltage.

The vector sum of the inductive and capacitive reactance is their numerical difference and is equal to $(\omega L - I/\omega C)I$.

In the diagram, ωLI is the greater but this need not necessarily be the case.

From the geometry of the vector diagram

$$(ZI)^2 = (RI)^2 + (\omega L - 1/\omega C)^2 I^2$$

dividing by I^2

$$Z^2 = R^2 + (\omega L - 1/\omega C)^2$$

$$Z = \sqrt{R^2 + (\omega L - 1/\omega C)^2}$$

This is the general formula for the impedance of a series circuit.

(b) In Fig. 3, the curves of current and voltage are not in phase since they do not pass through their zero values simultaneously. Because of this, a portion of the power represented by the product (current x volts) is negative during each cycle.

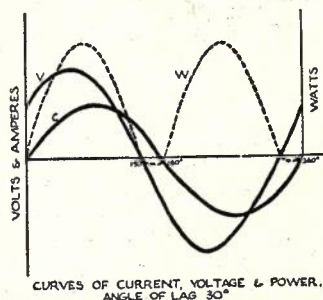

Q. 1, Fig. 3.

If these values of current and voltage existed in a circuit which did not contain inductance or capacitance, the two curves would always pass through zero at the same time then their product would always be positive and the average useful power would be greater than is the case for the condition illustrated in Fig. 3. Thus, considering Fig. 1 with given values of current and voltage, the power developed will not be simply

the product of these quantities but will depend upon the difference in phase between them.

The product of current and voltage is termed the "apparent watts."

The product, current x volts x power factor is termed the "true watts."

In general, the power factor is numerically equal to the cosine of the angle of phase difference between the voltage and the current.

$$\text{Power factor} = \cos \theta = \text{True watts}/\text{apparent watts.}$$

(c) Considering the impedance formula in (a), it will be seen that due to the minus sign in the reactance term, even if both ωL and $1/\omega C$ be large the impedance may be small because their difference may be small. The partial or complete cancellation of these two terms gives rise to a phenomenon known as resonance.

Since both inductive and capacitive reactance depend on frequency it follows that the frequency influences the values required for resonance. An increase in frequency will cause an increase in the inductive reactance and a decrease in the capacitive reactance so that for a circuit containing fixed values of inductance and capacitance the reactance can be varied by altering the frequency.

Perfect resonance can therefore always be obtained at one particular frequency although if the resistance is high it might not be very noticeable.

This frequency is known as the "resonant" frequency.

For perfect resonance

$$\omega L = 1/\omega C$$

$$\omega^2 = 1/LC$$

$$\omega = 1/\sqrt{LC}$$

$$\text{as } \omega = 2\pi f$$

$$f \text{ Resonant} = 1/2\pi\sqrt{LC}$$

Q. 2.—(a) What is meant by the R.M.S. or effective value of alternating current?

(b) A non-inductive circuit of resistance 15 ohms has a sinusoidal alternating potential applied to it, the maximum value of which is 1060.5 volts. What current flows in the resistance and what power in watts is dissipated in heat?

A.—(a) If a direct current I is sent through a circuit of resistance R the wire becomes heated and the power expended in heating the wire is equal to I^2R watts, or since R may be considered to be constant, the power expended is proportional to the square of the current. The equivalent A.C. is one which gives the same heating effect.

If an alternating current is sent through the same

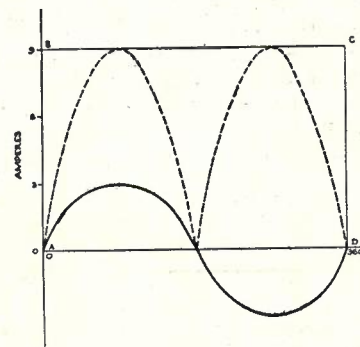

Q. 2, Fig. 1.

circuit the heating effect at each instant is proportional to the square of the current at that particular instant, the resultant total heating effect would therefore be

equal to the square root of the average value of the square of the current. This value is usually called the R.M.S. (root mean square) or effective value of an alternating current since it is the value which measures the heating effect.

The term root mean square is derived because the R.M.S. value is the square root of the mean value of the square of all the different values the current takes up in a complete cycle.

For power calculations and current carrying capacities of cables and wires, the R.M.S. values of current and voltage are used, the maximum value being used where insulation requirements are being specified.

It can be proved mathematically that in the case of a sine wave form the R.M.S. value = $1/\sqrt{2}$ maximum value.

(b)

$$\begin{aligned}
 E \text{ effective} &= 1/\sqrt{2} \times 1060.5 \\
 &= 750 \text{ volts approximately} \\
 I \text{ effective} &= E \text{ effective}/R = 750/15 \\
 &= 50 \text{ amps approximately.} \\
 \text{Power dissipated} &= I^2 R \\
 &= (50)^2 \times 15 \\
 &= 37,500 \text{ watts approximately.}
 \end{aligned}$$

Q. 3.—Express the total power in a balanced star connected three phase power distribution system in terms of the phase voltage, the phase current, and the power factor.

A three phase star connected motor of efficiency 90 per cent. delivers 100 B.H.P. at the pulley when the power factor is 0.8. Determine the current in each phase of the motor when the mains voltage is 400.

A.—(a) A three phase three wire star connected circuit is shown in Fig. 1. The relationship between the voltage between lines and between line and star

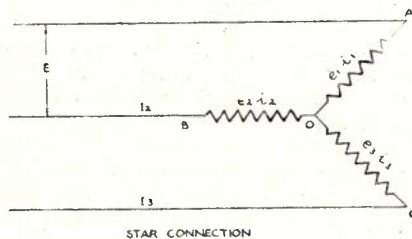

Q. 3, Fig. 1.

point can be obtained from consideration of the vector diagram shown in Fig. 2.

The voltage between lines is the vector difference of any two of the phase voltages. This is obtained by reversing one of the phase vectors and adding its reversed value to one of the others; OX. thus gives the line voltage between A and B.

From the geometry of the diagram the magnitude of OX. representing E is

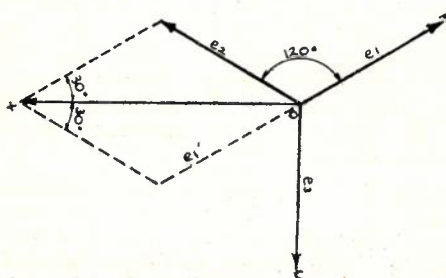

Q. 3, Fig. 2.

$$\begin{aligned}
 2 \text{ OB} \cos 30^\circ &= 2e_2 \times \sqrt{3}/2 \\
 \therefore E &= \sqrt{3} e_2 \\
 \therefore e_2 &= E/\sqrt{3}
 \end{aligned}$$

A similar result may be obtained for e_1 and e_3 . Thus, the voltage between any pair of lines is $\sqrt{3}$ times the voltage between any line and star point. The line current is the same as the current in the phase winding.

$$\begin{aligned}
 \text{The total power} &= 3 \times \text{the power per phase.} \\
 &= 3e_2 i_2 \cos \theta \\
 \text{but } e_2 &= E/\sqrt{3} \text{ and } i_2 = i_1 \\
 \therefore \text{the total power} &= 3 \times E/\sqrt{3} \times I \times \cos \theta \\
 &= \sqrt{3} EI \cos \theta.
 \end{aligned}$$

(b)

$$\begin{aligned}
 \text{Since } P &= \sqrt{3} EI \cos \theta \\
 \therefore I &= P/\sqrt{3} E \cos \theta \\
 &= 100/90 \times 100 \times 746 \\
 &= \frac{\quad}{\sqrt{3} \times 400 \times 0.8} \\
 &= 149.6 \text{ amperes approx.}
 \end{aligned}$$

Q. 4.—Show by means of a diagram the construction of a copper oxide type rectifier unit. Designate and explain the purpose of each component and illustrate the electrical performance of the rectifier by means of an impedance-voltage diagram.

Furnish two examples of the uses of metal rectifiers in the transmission path of long line plant. Explain the functions of each by means of schematic diagrams.

A.—(a) Fig. 1 illustrates the construction of a copper oxide type rectifier unit.

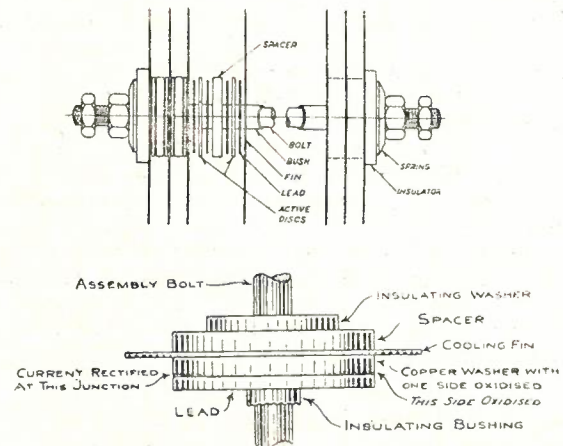

Q. 4, Fig. 1.

The rectifying element consists of a pure copper disc which has been oxidized on one side by special heat treatment. Usually, finely powdered graphite is rubbed into the surface of the oxide before assembling to ensure good contact and low resistance of the copper oxide surface. The rectifier discs are assembled on a screwed shaft from which they are insulated. Contact between the oxide and the adjacent disc is effected by lead washers which are usually coated with tin to render them non-reactive.

Radiating fins are inserted between pairs of rectifiers to dissipate heat and at the same time serve as conductors or connectors. Copper plated spacing washers are inserted between successive radiating fins to improve the ventilation of the unit.

The complete assembly is tightly clamped together by

means of a nut and spring washer pressing on to a moulded insulating washer.

The number of discs in series is determined by the D.C. voltage and the number of parallel groups is sufficient to carry the required D.C. current.

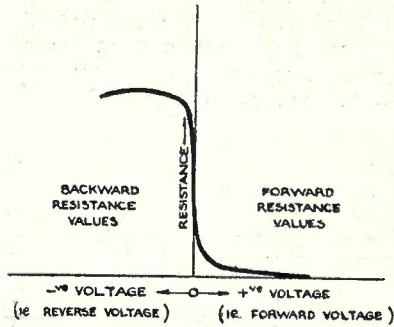

Q. 4, Fig. 2.

Fig. 2 illustrates the manner in which the resistance of a metal rectifier varies with variation in applied voltage, both in magnitude and sign. The ratio between the minimum value of forward resistance and the maximum value of backward resistance varies with different samples of rectifiers but may be expected to be at least of the order of 1 : 1000.

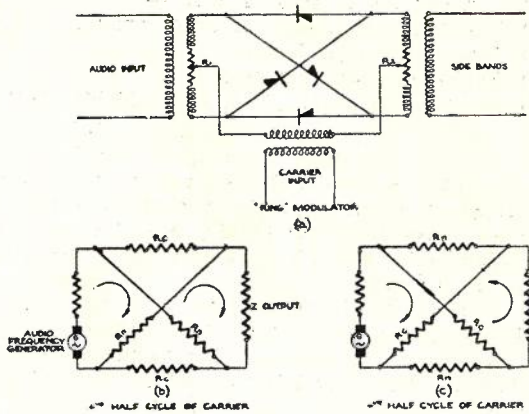

Q. 4, Fig. 3.

(b) Two examples of the use of metal rectifiers in the transmission path of long line plant are: (1) modulator, (2) voltage limiter.

In modern carrier systems, modulation and demodulation are effected by employing metal rectifier units and Fig. 3A indicates the arrangement of a typical modulator.

When the carrier voltage is large in comparison with the audio voltage, the resistance of the metal rectifier discs will be controlled by the carrier. During the time the carrier voltage passes through one complete cycle, pairs of the copper oxide discs become alternately conducting and non-conducting. The equivalent circuits for the two halves of the carrier frequency cycle are shown at (b) and (c) Fig. 3. R_c represents the resistance of a metal rectifier in the conducting direction and R_n the resistance in the non-conducting direction during half a cycle of the carrier frequency. Considering (b) and (c) the carrier frequency can be considered to act as a high speed commutator which

is continually reversing the direction of the voice current.

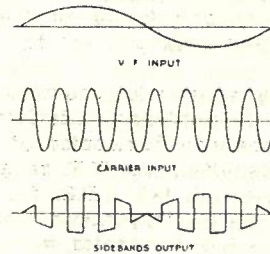

Q. 4, Fig. 4.

The resultant output wave form is shown in Fig. 4 and an analysis of this output wave shows that the main components are the major sum and difference components of the carrier and voice frequencies, namely the upper and lower side bands.

Voltage Limiter: The characteristics of metal rectifiers used as modulators and demodulators require that the voice input voltage shall be low in comparison with the applied carrier voltage. It is usual therefore to precede them by a voltage limiter whose function is to keep the input voltage to the modulator from exceeding a predetermined value, regardless of the level delivered by the subscriber. The circuit arrangements are shown in Fig. 5.

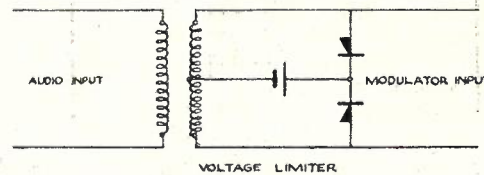

Q. 4, Fig. 5.

The rectifier is normally biased to a potential which makes its impedance high so that normally the shunt loss on transmission is negligible. If speech voltage (after transformation) exceeds the biased potential, the impedance falls to a very low value and produces a shunting effect across the modulator input, thus preventing over-loading.

Q. 5.—Explain the reason why it is usual to superimpose not more than 18 voice frequency carrier telegraph channels on a 4-wire voice frequency telephone circuit (carrier telephone channel classed as a 4-wire circuit).

Give a block schematic sketch of an 18 channel V.F. carrier telegraph terminal and describe briefly the functions of each component.

A.—(a) The average telephone channel has an approximately flat frequency response between 300 C.P.S. and 2,600 cycles per second, or it can be readily equalized over this range, and this consideration sets the lower and upper limits to the choice of telegraph signalling frequencies for the multi channel V.F. telegraph system which must be capable of operation on a normal telephone circuit.

The telegraph transmission speed determines the frequency band width required for each channel and the system is designed to cater for a transmission speed of 66 bauds. The system therefore requires a band width of 33 C.P.S. on either side of the carrier

frequency, i.e., a band width of 66 C.P.S. for each channel. In practice, the channel width must be somewhat greater than this owing to the frequency characteristics of the band pass filters, as it is desirable that the filter response be linear over the essential band width.

The actual frequencies used are chosen with a view to prevention of inter-channel interference and these frequencies are the odd harmonics of 60 C.P.S. providing 18 channels within the V.F. range, each channel having a separation of 120 C.P.S. from neighbouring channels. The channel frequencies employed are 420—2460 C.P.S. and any harmonics which might be produced fall within the range of maximum attenuation of adjacent filters.

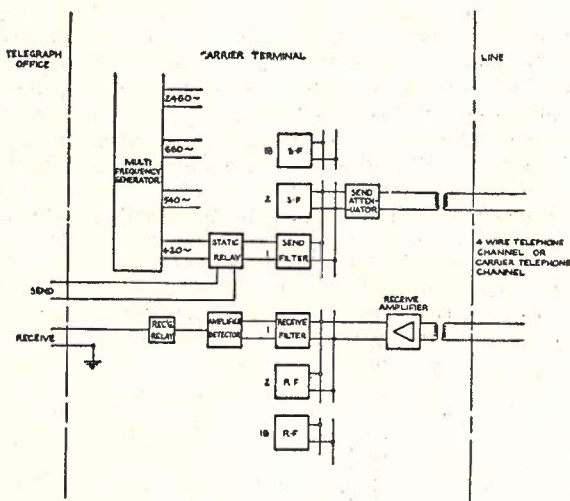

Q. 5, Fig. 1.

(b) A block schematic diagram of an 18 channel V.F. carrier telegraph terminal is shown in Fig. 1.

Transmitting Circuit: Telegraph signals consisting of positive and negative impulses are applied to the static relay which is also supplied with the appropriate channel frequency either from an oscillator or a multi frequency generator.

In the static relay the telegraph signals control the carrier frequency so as to produce impulses corresponding to the applied signals. In other words, the carrier frequency is subjected to a high attenuation when a spacing signal is applied and a low attenuation when a marking signal is applied. Unwanted frequencies generated in the static relay are rejected by the send filter. The wanted frequencies are passed to line via an attenuator (which serves to adjust the sending level) and a line transformer.

Receiving Circuit: Incoming signals pass through the line transformer to a receiving amplifier, the level offered to the receive filters being adjusted by a receive attenuator. After amplification, the signals are passed to the receiving filters, each of which selects its allotted frequency.

In each channel, signals are then applied to the amplifier detector where they are converted to D.C. impulses which operate a telegraph receiving relay, the contacts of which apply positive and negative signals to the Telegraph Office in accordance with those originated at the transmitting end.

The amplifier detector includes an automatic volume control circuit so that the detected current through the receiving relay will remain substantially constant over a wide variation in signal level, thus preventing signal

distortion which would otherwise occur due to daily variations in line attenuation or signal level.

Q. 6.—A three channel carrier telephone system consisting of two terminals is superimposed on a physical aerial wire circuit by the use of 5.6 K.C. filters. It is reported that speech over channel number 3 in the B to A direction is distorted. List the possible sources of trouble and discuss the causes in each case. Which of these is the most common in practice and how would you proceed to eliminate the cause?

A.—

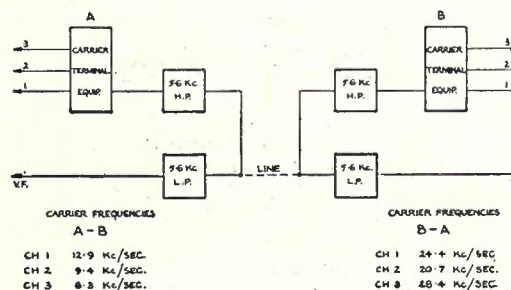

Q. 6, Fig. 1.

A.—(a) Fig. 1 is a block schematic. The trouble will be confined to individual apparatus in the carrier terminal equipment, namely, transmitting side B terminal and receiving side A terminal.

Common sources of trouble are:—

- (1) Frequency drift—out of synchronism.
- (2) Incorrect carrier level.
- (3) Faulty demodulator amplifier.
- (4) Incorrect filament, plate, and grid bias batteries.

(1) Lack of synchronism between the modulator oscillator at the transmitting end and the demodulator oscillator at the receiving end can cause distortion. Alteration of oscillator frequency could result from faulty valves or incorrect battery supplies to filament, plate, and grid circuits. Temperature variation is another likely cause.

(2) If metal rectifiers are employed as modulators and demodulators their satisfactory operation depends on a high carrier level in relation to the voice or side band input. If this level is reduced distortion is likely to result.

(3) If metal rectifier demodulation is employed, it is necessary to succeed it with a V.F. amplifier to restore the voice frequency signals to the correct level for application to the trunk switchboard. Distortion could result in this circuit due to overloading, faulty valves or incorrect filament, plate, and grid bias voltages.

(4) If valve modulation and demodulation is employed, similar faults outlined for the demodulator amplifier could cause distortion.

(b) The most common trouble would be—out of synchronism.

(c) The general procedure for synchronization is to send simultaneously upper and lower side bands of 1000 c.p.s. in one direction over the channel by patching 1000 cycle test tone to hybrid line. The modulator band filter at the transmitting terminal and the demodulator band filter at the receiving terminal must be patched out of circuit to permit the transmission of both side bands. In listening at the receiving terminal to the demodulated side bands if there is any difference of frequency between the modulator and demodulator oscillators the two side bands received will audibly beat together. The demodulator oscillator condenser is

adjusted until the beats are slower than one per second.

When one direction of a channel has been synchronized by transmitting both side bands, the band filters are re-connected into circuit, thus allowing a single modulated 1000 c.p.s. tone to be sent over the channel in the direction already synchronised. The other direction of this channel is then synchronized by looping this tone back to the transmitting terminal by patching at the receiving terminal to the input of the transmitting side of the channel. The transmitting terminal then listens on the channel on which tone is being sent and both transmitted and received tones will be audible. If there is any difference, the demodulator oscillator condenser is adjusted until the beats are slower than one per second. The double side band method must be applied to one direction before looping back for synchronism in the other direction.

In the case under consideration, this test would need to be carried out in the B to A direction, the demodulator oscillator condenser at the A terminal being adjusted to obtain synchronism.

SECTION 3.

Q. 7.—Describe an armature of a D.C. generator and explain in detail, illustrated by a simple sketch, the function of the commutator.

A wooden armature 10 cm. long and 6 cm. in diameter is wound with twenty turns of wire and rotates at a speed of 1,800 r.p.m. in a uniform magnetic field of strength 5,000 lines per square cm. Calculate the maximum voltage generated at the ends of the coil.

A.—An armature consists of a cylindrical soft iron core which has a series of parallel longitudinal slots in which the armature coils are laid. The core is usually made up from a large number of laminated stampings, the laminations being at right angles to the axis of the armature and insulated from each other to reduce eddy currents. The stampings are held in position by end plates and bolts, which pass through, but are insulated from the core. In some cases the stampings are cut to allow free circulation of air for cooling purposes. The slots around the periphery of the laminated core plates are termed armature teeth and when laid up in the complete core form the longitudinal slots in which the armature coils are laid.

The complete core is keyed to a steel shaft which is shouldered to retain the armature in the correct position with respect to the bearings and is proportioned to withstand the twisting strain. The shaft, which runs in bearings, also carries the commutator and a pulley or coupling device for connection to the driving source.

The armature conductors usually consist of insulated copper wires and these are insulated from the core by strong paper or canvas. With slotted armatures, retaining wedges of wood or fibre keep the armature coils firmly in position. The complete assembly is bound and coated with varnish. Each coil consists of two armature conductors situated in slots one pole pitch apart.

The junctions of the coils are joined to the commutator, which has as many segments as there are coils.

A typical method of connecting armature coils together is the lap connection illustrated in Fig. 1.

This shows a lap winding opened out so as to lie entirely in one plane. It is necessary, in order that the E.M.F. generated in the two conductors forming a coil shall each produce a current flowing around the coil in the same direction, that these two conductors

shall be at any instant in corresponding positions with respect to two magnetic poles of opposite polarities.

With the lap winding the coil is bent back on itself so that the completed winding forms a series of loops

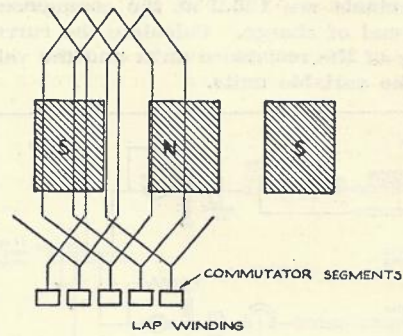

Q. 7, Fig. 1.

overlapping each other, the connection between two loops being joined to a commutator segment.

Fig. 2a is a view of a simplified generator having a one turn coil connected to the two segments of a simple commutator. When the coil is turned through one

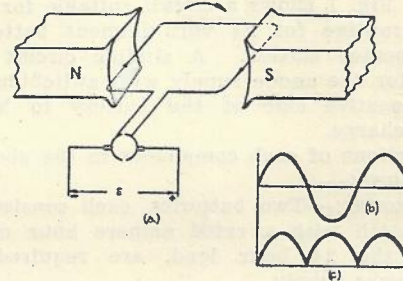

Q. 7, Fig. 2.

revolution the E.M.F. generated in the coil has a sine wave form (Fig. 2b).

It will be noted that it reverses every half cycle because the direction of motion of each conductor relative to the direction of the magnetic field changes each half revolution. If the ends of the coil are connected to the simple commutator, as shown, then at the moment when the generated E.M.F. is passing through zero, the connections of the external circuit via the brushes bearing on the commutator are reversed. The voltage E at the brush terminals therefore becomes uni-directional and is of the form shown in Fig. 2c.

A practical generator has many coils and corresponding commutator segments which have the effect of almost eliminating the fluctuations in the voltage at the generator terminals.

(b)

$$E_{Max.} = 2 B l v N \times 10^{-8}$$

where B = flux density in lines per sq. cm.

l = length in centimetres

v = peripheral velocity in cms. per sec.

N = Number of conductors

Peripheral Velocity

$$= \pi \times 6 \times 1800 / 60$$

$$= 180\pi$$

$$E_{Max} = (2 \times 5000 \times 10 \times 180 \times \pi \times 20) / 10^8$$

$$= 11.3 \text{ Volts approx.}$$

Q. 8.—Draw a schematic diagram of the power circuit at a carrier repeater station using anode and filament batteries and D.C. motor generators working on a charge discharge basis. Describe the functions of each component.

A 130 volt 72 ampere hour battery has an efficiency of 90 per cent. The battery must be charged in 8 hours from the 200 volt D.C. mains using a fixed and a variable resistance in series. The voltages at the battery terminals are 135.2 at the commencement and 182 at the end of charge. Calculate the current carrying capacity of the resistance units and the value of the fixed and the variable units.

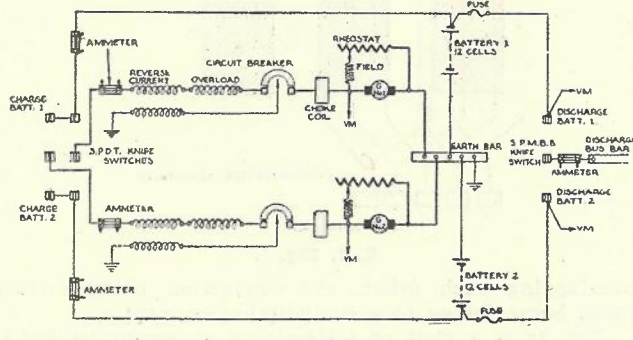

POWER CIRCUIT
CARRIER REPEATER STATION
Q. 8, Fig. 1.

A.—(a) Fig. 1 shows a circuit suitable for a charge-discharge routine for 24 volt filament batteries at a carrier repeater station. A similar circuit could be employed for the anode supply with switching arranged for the negative side of the battery to be earthed during discharge.

The functions of each component in the above circuit are as follows:—

(1) Batteries:—Two batteries, each consisting of 12 cells and each with a rated ampere hour capacity to cater for the 24 hour load, are required for the filament power supply.

Two batteries each 66 cells are required for the anode power supply. Ampere hour capacity rating similar to filament battery requirements.

(2) Generators:—Two generators, 35 volt, with a rated output capable of charging a battery at the 10 hour rate, are required for the filament power supply.

Generator output should be adjustable by means of a field rheostat.

Two generators, 180 volt, similar rating and control, are required for the anode power supply.

(3) Circuit Breaker:—This includes overload and reverse current coils. The overload coil protects the battery from any sudden variations in main supply. The reverse current coil prevents the battery discharging and driving the generator as a motor if the main supply fails.

(4) Charge and Discharge Switches:—Two S.P.D.T. charge switches are required so that either battery can be charged by either generator as required.

A S.P.M.B.B. switch is provided so that either battery can be connected to the discharge bus-bar as required without breaking the continuity of the circuit.

(5) Fuses:—These are provided in the battery discharge leads to protect it from short circuits.

(6) Ammeter and Voltmeter taps:—Meters are included on the power boards so that charge and discharge currents and voltages may be rapidly checked.

- (b) Total ampere hours
- = $72 / 0.9 \times 1/8$
- = 10 amp's.
- = current carrying capacity of resistance.

At commencement of charge mains E.M.F. is 200 V. and battery E.M.F. is 135.2 V.

∴ Effective E.M.F. = 64.8
 ∴ Value of charging resistance = $64.8 / 10$
 = 6.48 ohms.
 At the end of charging, effective E.M.F. = $200 - 182$
 = 18 V.
 ∴ resistance = $18 / 10$
 = 1.8 ohms
 variable resistance should be $6.48 - 1.8 = 4.68$ ohms
 fixed resistance = 1.8 ohms.

Q. 9.—Draw and describe the voltage characteristics of a shunt, a series and a compound wound generator. Explain what is meant by the "Regulation" of a generator and show by formula how "Regulation" is expressed as a percentage.

A.—(a) The external characteristics of a shunt wound generator are shown in Fig. 1a.

The terminal voltage drops as the current taken from the machine is increased for the following reasons:—

- (a) The flux per pole is reduced by armature reaction;
- (b) The armature drop $I_a R_a$ is used up in the machine;
- (c) The field current $I_f = E_t / R_f$ where R_f is the resistance of the shunt field circuit, and E_t is the terminal voltage on load, therefore, as the terminal voltage drops the exciting current decreases and causes a further voltage drop.

The external characteristics of a compound wound generator are shown in Fig. 1b. The compound generator maintains the terminal voltage approximately

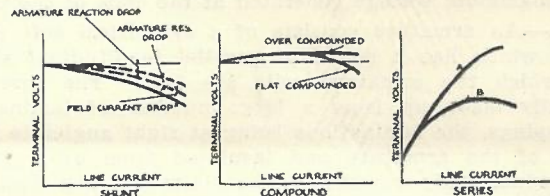

Q. 9, Fig. 1.

constant from no load to full load. This is because the line current passes through the series field coils and causes the total excitation to increase with the load. With a large number of series turns, the total excitation may be so increased that the terminal voltage will rise, i.e., it is over compounded.

When the terminal voltage has the same voltage at full load as no load, the machine is said to be flat compounded.

The external characteristics of a series generator are shown in Fig. 3b. Curve A shows the relation between voltage and current in a series generator if armature resistance and armature reaction were negligible. The voltage increases with the load current since this is also the exciting current.

Curve B shows the actual relation between terminal voltage and load current. The voltage drop between curves A and B is made up of the drop due to armature reaction and armature resistance.

(b) The regulation of a generator is the change in voltage with variation in load, the speed and field current remaining constant. It is usually expressed as the difference between the no load and full load voltage with constant excitation and can thus be expressed as a percentage of the full load voltage.

$$\text{Percentage Regulation} = 100(E_0 - E_t) / E_t$$

Where E_0 is the terminal voltage on open circuit and E_t is the terminal voltage on full load.

BOARD OF EDITORS :

A. R. GOURLEY, A.M.I.E. (Aust.).
J. A. KLINE, B.Sc., A.M.I.E.E.
R. M. OSBORNE, M.E.E., A.M.I.E.E.

POLICY :

THE object of the Postal Electrical Society of Victoria is to promote diffusion of knowledge in the communication services of the Post Office.

In advancing this object by the publication of this Journal the Board of Editors is not responsible for the statements made or the opinions expressed in any of the articles in this Journal, unless such statement is made specifically by the Board.

Editors are welcome to use not more than one-third of any article provided credit is given at the beginning or end, thus:—From "The Telecommunication Journal of Australia."

DISTRIBUTION :

This Journal is available to members of the Postal Electrical Society of Victoria without charge. Other officers of the Postmaster General's Department may obtain copies of all publications of the Society on the payment in advance of 4/- p.a. Single copies of this Journal are available at 2/- each.

COMMUNICATIONS :

All communications should be addressed to:—

A. R. GOURLEY,
Hon. Secretary, Postal Electrical Society of Victoria,
G.P.O. Box 4050, Melbourne.

All remittances should be made payable to "The Postal Electrical Society of Victoria," and not negotiable.



Ruskin Press Pty. Ltd.
123 Latrobe Street
Melbourne